

# Chapter 6

# NETWORK CALCULUS

Roger Wattenhofer

ETH Zurich – Distributed Computing – [www.disco.ethz.ch](http://www.disco.ethz.ch)

## Overview

- Motivation / Introduction
- Preliminary concepts
- Min-Plus linear system theory
- The composition theorem
- Adversarial queuing theory
- Instability of FIFO
- Stability of LIS
- Sections 1.2, 1.3, 1.4.1
- Section 3.1
- Section 1.4.2

in Book “Network Calculus” by  
Le Boudec and Thiran

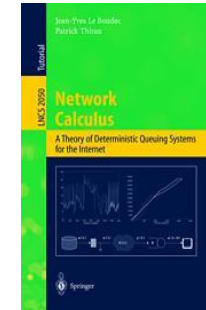

[ica1www.epfl.ch/PS\\_files/NetCal.htm](http://ica1www.epfl.ch/PS_files/NetCal.htm)

6/2

## What is Network Calculus/Adversarial Queuing Theory?

- Problem: Queuing theory (Markov/Jackson assumptions) **too optimistic**.
- Instead: Worst-case analysis (with bounded adversary) of queuing or flow systems arising in communication networks
- Network Calculus
  - Algebra developed by networking (“EE”) researchers
- Adversarial Queuing Theory
  - Worst-case analysis developed by algorithms (“CS”) researchers

## An example

- assume  $R(t)$  = sum of arrived traffic in  $[0, t]$  is known
- required **buffer** for a bit rate  $c$  is
 
$$\sup_{s \leq t} \{R(t) - R(s) - c \cdot (t-s)\}$$

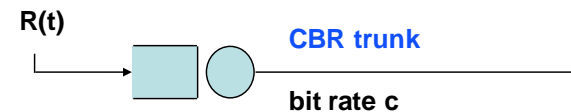

6/3

6/4

## Arrival and Service Curves

- Similarly to queuing theory, Internet integrated services use the concepts of *arrival curve* and *service curves*

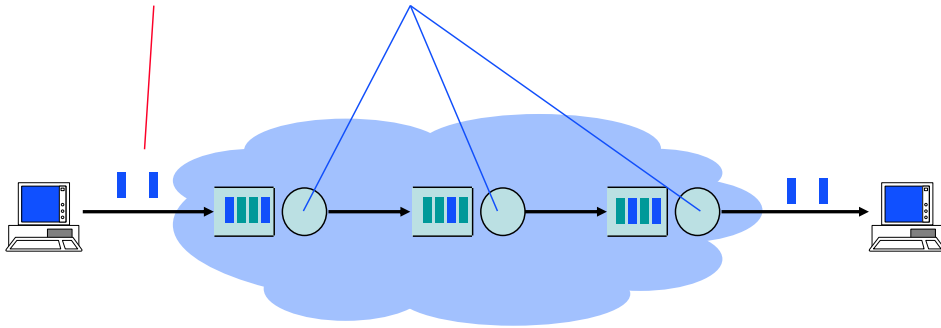

6/5

## Arrival Curves

- Arrival curve  $\alpha$ :  $R(t) - R(s) \leq \alpha(t-s)$ , for all pairs  $s \leq t$ .

Examples:

- leaky bucket  $\alpha(u) = ru + b$
- reasonable arrival curve in the Internet  $\alpha(u) = \min(pu + M, ru + b)$

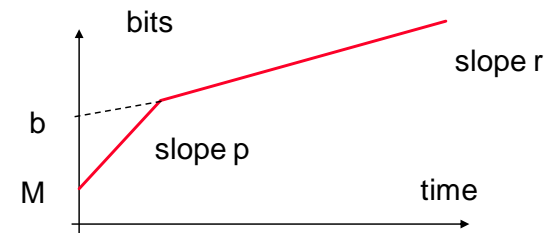

6/6

## Arrival Curves can be assumed sub-additive

- Theorem (without proof):  
 $\alpha$  can be replaced by a *sub-additive* function
- sub-additive means:  $\alpha(s+t) \leq \alpha(s) + \alpha(t)$
- concave  $\Rightarrow$  subadditive

## Service Curve

- System S offers a service curve  $\beta$  to a flow iff for all  $t$  there exists some  $s$  such that

$$R^*(t) - R(s) \geq \beta(t - s)$$

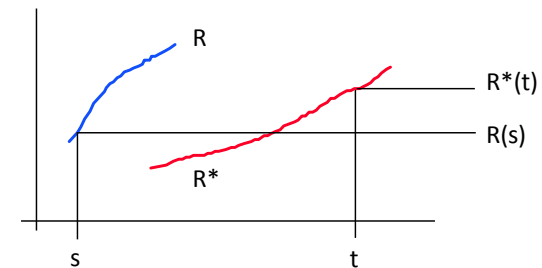

6/7

6/8

Theorem: The constant rate server has service curve  $\beta(t)=ct$

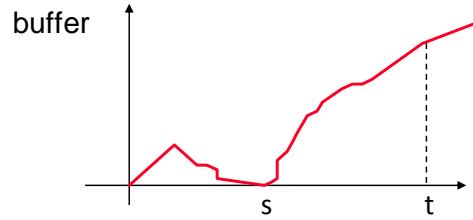

**Proof:** take  $s$  = beginning of busy period. Then,

$$R^*(t) - R^*(s) = c \cdot (t-s)$$

$$R^*(t) - R(s) \geq c \cdot (t-s)$$

The guaranteed-delay node has service curve  $\delta_T$

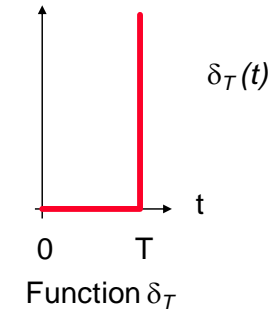
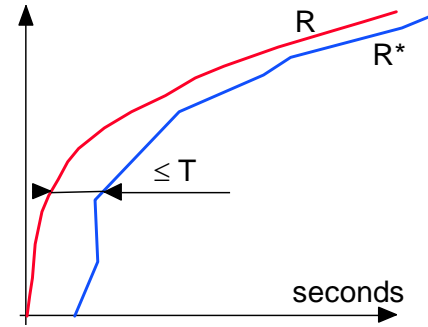

6/9

6/10

A reasonable model for an Internet router

- rate-latency service curve

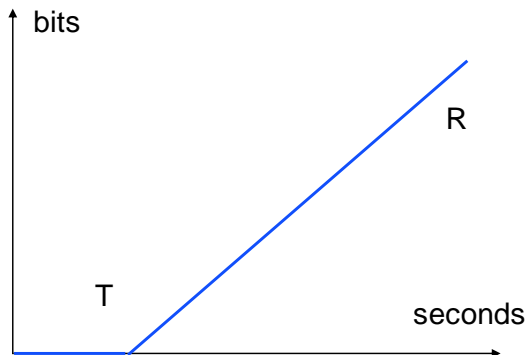

Tight Bounds on delay and backlog

If flow has arrival curve  $\alpha$  and node offers service curve  $\beta$  then

- backlog  $\leq \sup (\alpha(s) - \beta(s))$
- delay  $\leq h(\alpha, \beta)$

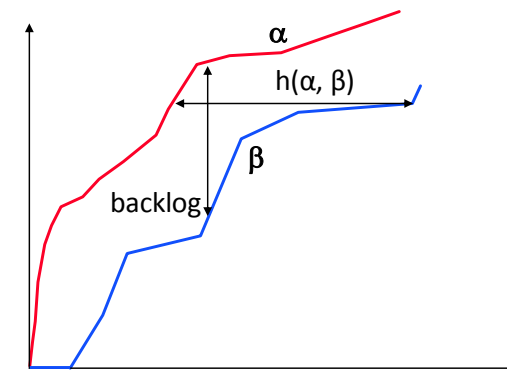

6/11

6/12

## For reasonable arrival and service curves

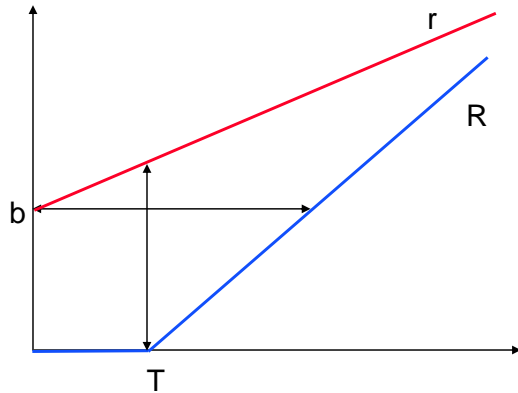

- delay bound:  $b/R + T$
- backlog bound:  $b + rT$

## Another linear system theory: Min-Plus

- Standard algebra:  $\mathbb{R}, +, \times$   
 $a \times (b + c) = (a \times b) + (a \times c)$

- Min-Plus algebra:  $\mathbb{R}, \min, +$   
 $a + (b \wedge c) = (a + b) \wedge (a + c)$

6/13

6/14

## Min-plus convolution

- Standard convolution:

$$(f * g)(t) = \int f(t-u)g(u) du$$

- Min-plus convolution

$$f \otimes g(t) = \inf_u \{ f(t-u) + g(u) \}$$

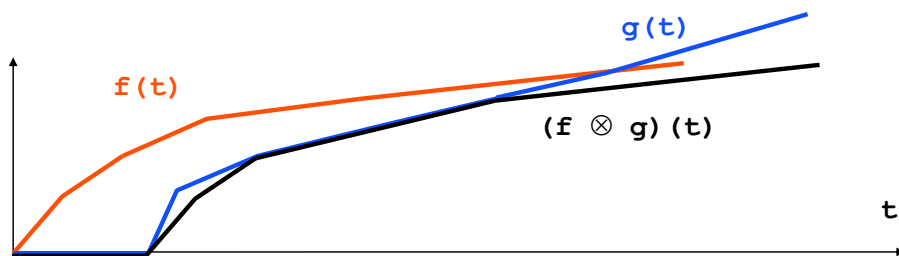

6/15

## Examples of Min-Plus convolution

- $f \otimes \delta_T(t) = f(t-T)$
- convex piecewise linear curves, put segments end to end with increasing slope

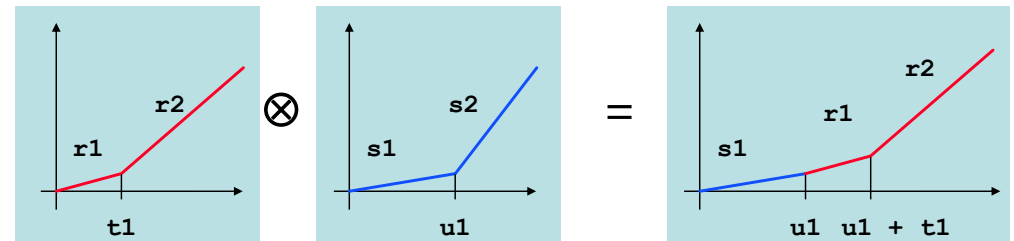

6/16

# Arrival and Service Curves vs. Min-Plus

- We can express arrival and service curves with min-plus

- Arrival Curve property means

$$R \leq R \otimes \alpha$$

- Service Curve guarantee means

$$R^* \geq R \otimes \beta$$

6/17

# The composition theorem

- Theorem:** the concatenation of two network elements offering service curves  $\beta_1$  and  $\beta_2$  respectively, offers the service curve  $\beta_1 \otimes \beta_2$

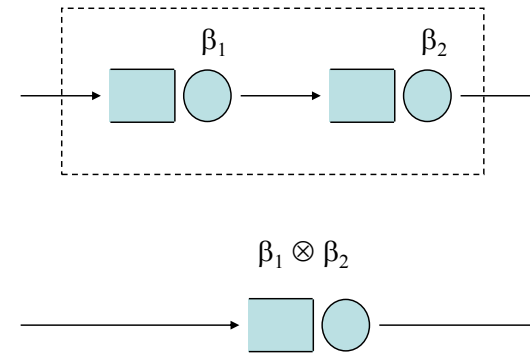

6/18

# Example: Tandem of Routers

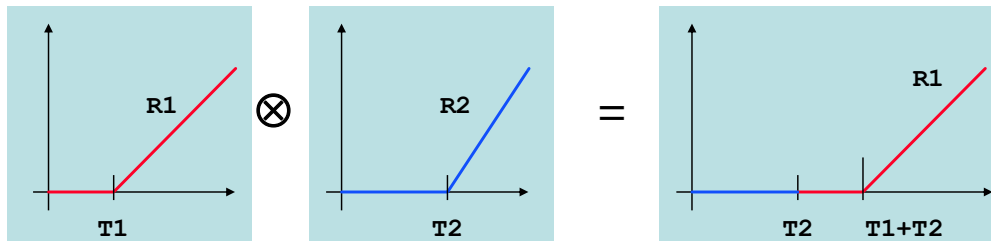
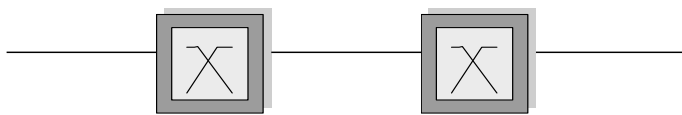

6/19

# Pay Bursts Only Once

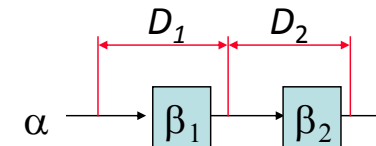

$$D_1 + D_2 \leq (2b + RT_1) / R + T_1 + T_2$$

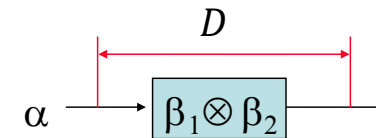

$$D \leq b / R + T_1 + T_2$$

end-to-end delay bound is less

6/20

## Adversarial Queuing Theory

- We will revise several models of **connectionless** packet networks.
- We have a **bounded adversary** which defines the network traffic.
  - Like network calculus
- Our objective is to study **stability** under these adversaries.
  - If a network is stable, we study latency.
- [Thanks to Antonio Fernández for many of the following slides.]

6/21

## Network Model

- The general network model assumed is as follows
  - A network is a directed graph.
  - Packets arrive continuously into the nodes of the network.
  - Link queues are not bounded.
  - A packet has to be routed from its source to its destination.
  - At each link packets must be scheduled: if there are several candidates to cross, one must be chosen by the scheduler.
- To make the analyses simpler initially, we assume
  - All packets have the same unit length.
  - All links have the same bandwidth.
  - This allows to consider a **synchronous** system, that is, the network evolves in steps. In each step each link can be crossed by at most one packet.

6/22

## Example

- We are given two packets, each needs to cross three links.
- There is congestion on the link  $B \rightarrow D$ , the execution needs 4 steps.

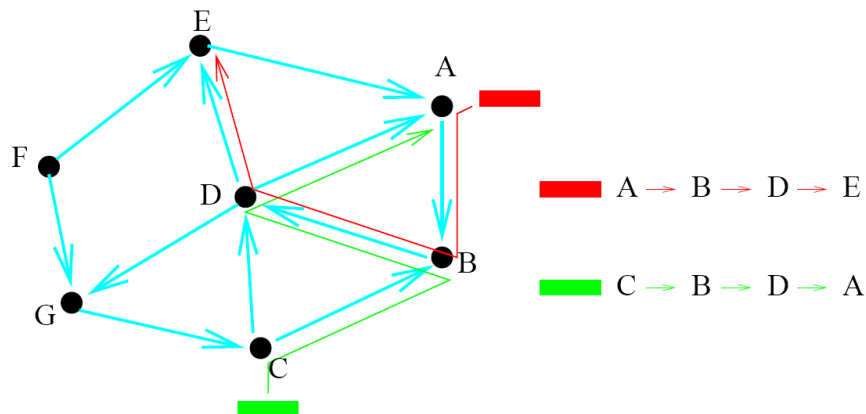

/23

## Adversarial Queuing Theory Model

- [Borodin, Kleinberg, Raghavan, Sudan, Williamson, STOC96]
- [Andrews, Awerbuch, Fernandez, Kleinberg, Leighton, Liu, FOCS96]
- There is an adversary that chooses the arrival times and the routes of all the packets
- The adversary is bounded by parameters  $(r, b)$ , where  $b \geq 1$  is an integer and  $r \leq 1$ , such that, for any link  $e$ , for any  $s \geq 1$ , at most  $rs + b$  packets injected in any  $s$ -step interval must cross edge  $e$ .
- We have a scheduling problem.

6/24

## Stability

- A scheduling policy  $P$  is **stable** at rate  $(r, b)$  in a network  $G$  if there is a bound  $C(G, r, b)$  such that no  $(r, b)$ -adversary can force more than  $C(G, r, b)$  simultaneous packets in the network.
- A scheduling policy  $P$  is **universally stable** if it is stable at any rate  $r < 1$  in any network.
- A network  $G$  is **universally stable** if it is stable at any rate  $r < 1$  with any greedy scheduling policy.

6/25

## Some Results

- Any directed acyclic graph (**DAG**) is universally stable, even for  $r = 1$  [BKRSW01].
- The **ring** is universally stable
  - There are never more than  $O(bn/(1 - r))$  packets in any queue.
  - A packet never spends more than  $O(bn/(1 - r)^2)$  steps in the system.
  - Any added link makes the ring unstable with some greedy policy (for instance with Nearest-to-Go, NTG).

- **FIFO is unstable** for  $r > 0.85$  with these networks:

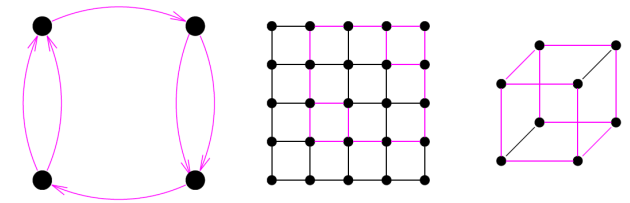

6/26

## Proof of FIFO Instability

- Initially we have  $s$  packets in a queue with a given configuration.
  - Think of these packets to be inserted in an initial burst
- Then the algorithm proceeds in **phases**
  - Each phase is a bit longer than the phase before.
  - After each phase, we have the initial configuration, however, with more packets in a specific queue than in the previous phase.
  - By chaining infinite phases, any number of packets in the system can be reached.
- We show here the behavior of the adversary and the system in one phase.
  - Each phase has three **rounds**.

6/27

## Initial Situation

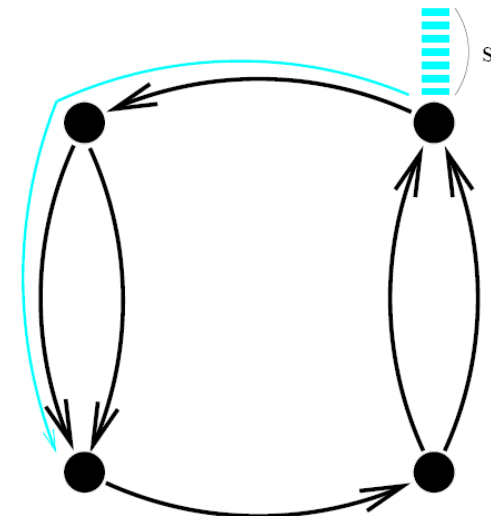

6/28

Injecting packets in the first round (s steps)

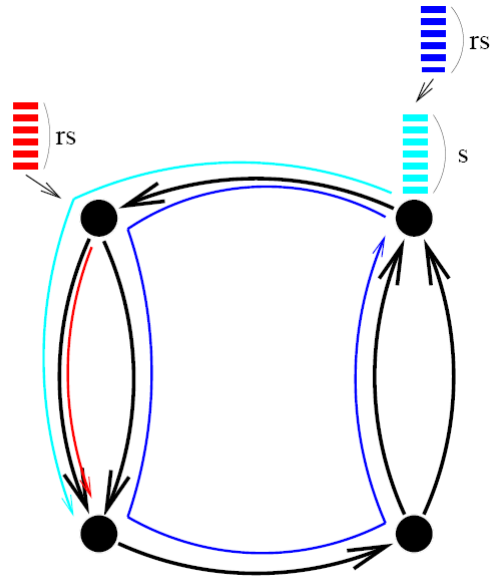

6/29

Situation after the first round

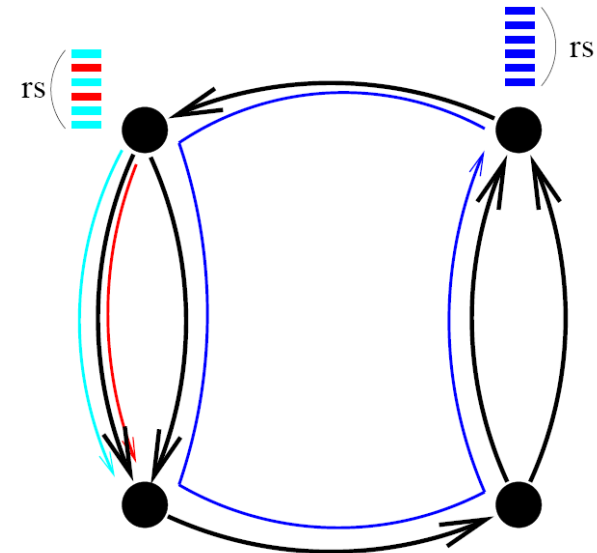

6/30

Injecting packets in the second round (rs steps)

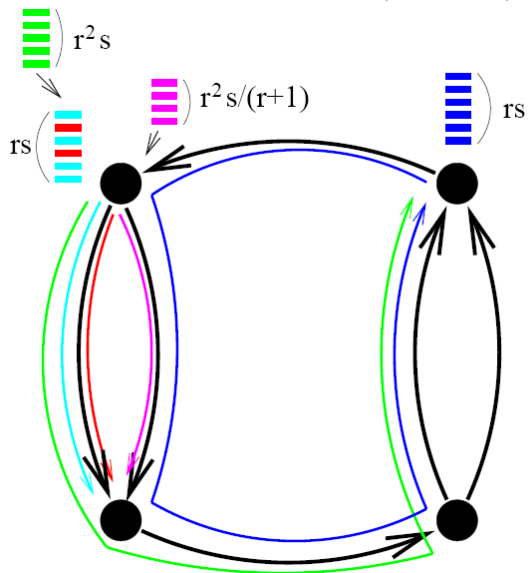

6/31

Situation after the second round

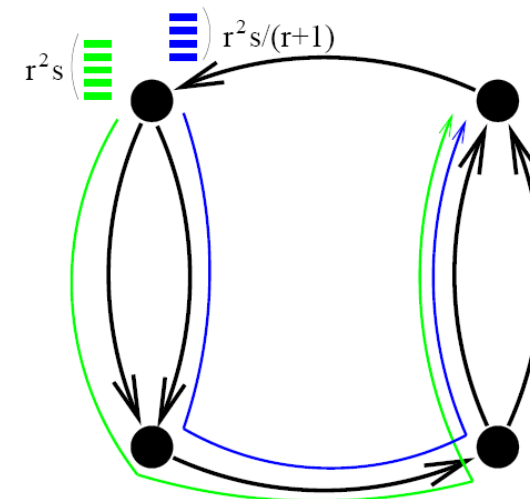

6/32



## Injecting packets in the third round ( $r^2s$ steps)

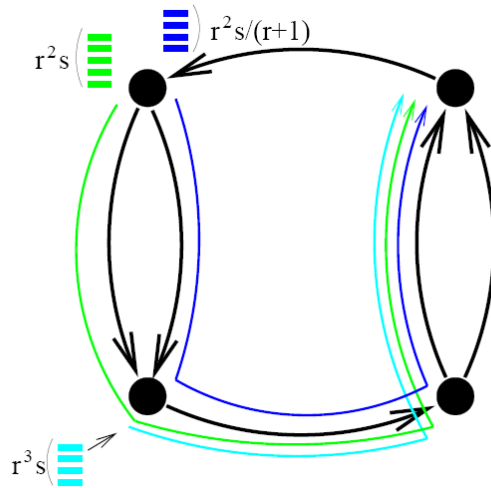

6/33

## Final situation (end of phase, after the third round)

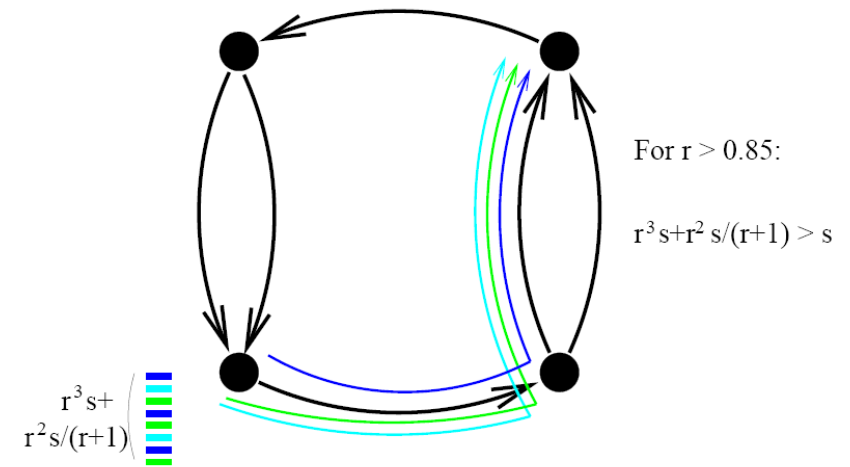

6/34

## More Results

- Several simple greedy policies are universally stable
  - Longest-in-System (LIS): Gives priority to oldest packet (in the system).
  - Shortest-in System (SIS): Gives priority to newest packet (in the system).
  - Farthest-to-Go (FTG): Gives priority to the packet farthest from destination.
  - Nearest-to-Source (NTS): Gives priority to the packet closest to its origin.
- All mentioned greedy policies can suffer delays that are exponential in  $d$ , where  $d$  is the maximum routing distance.
  - Moreover, any deterministic policy that does not use information about the packet routes to schedule can suffer delays exponential in  $\sqrt{d}$  [Andrews Z 04].
  - There are deterministic distributed algorithms that guarantee polynomial delays and queue lengths [Andrews FGZ 05].

6/35

## Universal stability of LIS (Longest-in-System)

- Network  $G$ , adversary in bucket AQT with parameters  $r = 1 - \varepsilon < 1$  and  $b \geq 1$ .
- Def.: Class  $L$  is the set of packets injected in step  $L$ .
- Def.: A class  $L$  is **active** at the end of step  $t$  if there are some packets of class  $L' \leq L$  in the system at the end of step  $t$ .
- Let us consider a packet  $p$  injected in step  $T_0$ . Packet  $p$  must cross  $d$  links, it crosses the  $i$ -th link in step  $T_i$ .
- Def.:  $c(t)$  is the number of active classes at the end of step  $t$ . Let  $\mathbf{c} = \max_{T_0 \leq t < T_d} c(t)$ , that is the maximum number of active classes during the lifetime of packet  $p$ .

6/36

Lemma:  $T_d - T_0 \leq (1 - \varepsilon^d)(c + \frac{b}{1-\varepsilon})$ .

- p arrives to the queue of its  $i^{\text{th}}$  link in  $T_{i-1}$ .
- Only the packets in  $c - (T_{i-1} - T_0)$  active classes can block p.
- There are no more than  $(1-\varepsilon)(c + T_0 - T_{i-1}) + b$  packets in these classes (p included), that is at most  $(1-\varepsilon)(c + T_0 - T_{i-1}) + b - 1$  packets can block p. Then,

$$\begin{aligned} T_i &\leq T_{i-1} + (1 - \varepsilon)(c + T_0 - T_{i-1}) + b \\ &= \varepsilon T_{i-1} + (1 - \varepsilon)(c + T_0) + b. \end{aligned}$$

$$\begin{aligned} T_d &\leq ((1 - \varepsilon)(c + T_0) + b) \sum_{i=0}^{d-1} \varepsilon^i + \varepsilon^d T_0 \\ &= ((1 - \varepsilon)(c + T_0) + b) \frac{1 - \varepsilon^d}{1 - \varepsilon} + \varepsilon^d T_0 \\ &= (1 - \varepsilon^d)(c + \frac{b}{1 - \varepsilon}) + T_0 \end{aligned}$$

6/37

Lemma: Bounding both classes and steps

- Let t be the first time when either the system features more than c **classes**, or there is a packet in the system for more than c **steps**, for some c.
- Clearly, "**classes**" cannot be violated first, because there can only be c+1 classes if there is at least one packet in the system for at least c+1 steps.
- So we know that "steps" must be violated first. Let p be a first packet which is in the system for at least c+1 steps. (Note that during this time, we had at most c classes.)
- Let  $c = b/((1-\varepsilon)\varepsilon^d)$ . Then the packet p cannot be in the system for more than c steps, because using our previous lemma (and  $b \geq 1$  and  $\varepsilon > 0$ ), the number of steps of p is bounded:

$$(1 - \varepsilon^d)(c + \frac{b}{1 - \varepsilon}) + 1 = c - \varepsilon^d b / (1 - \varepsilon) + 1 < c + 1$$

6/38

Theorem: LIS is universally stable

- Each packet leaves the system after  $c = b/((1-\varepsilon)\varepsilon^d)$  steps.
- In addition one can show that there are at most  $b+b/\varepsilon^d$  packets in each queue at all times.

- That's all folks!

6/39