

Chapter 9 GSM

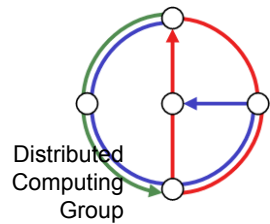

Mobile Computing
Summer 2004

Overview

- GSM Overview
- Services
- Architecture
- Cell management
- TDMA, FDMA
- Orientation
- Handover
- Authentications
- HSCSD, GPRS



Mobile phones worldwide

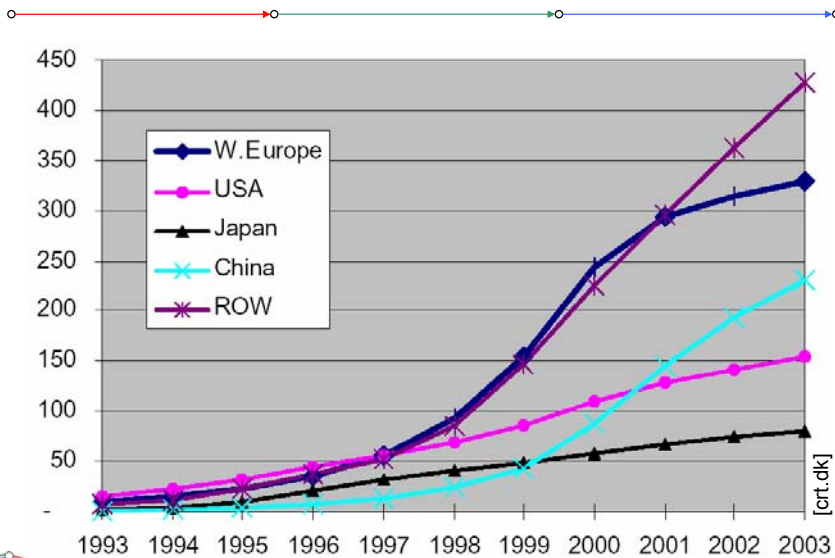

Mobile phone subscribers worldwide

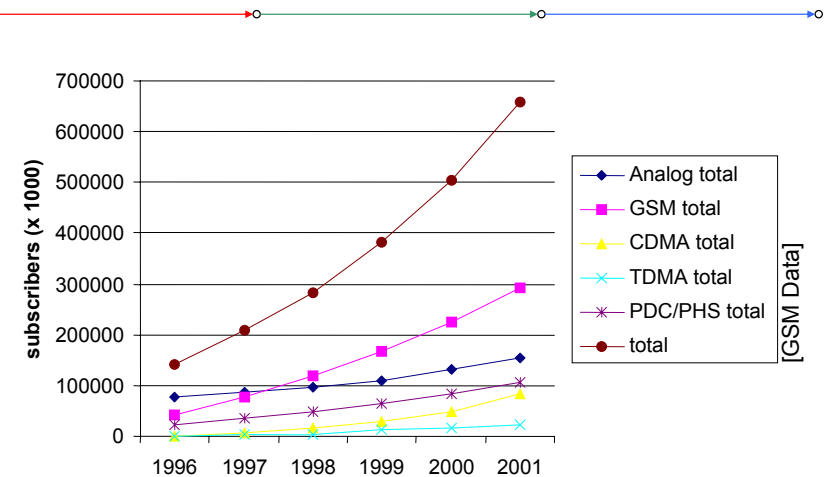

GSM: Overview

- formerly: Groupe Spéciale Mobile (founded 1982)
- now: Global System for Mobile Communication
- Pan-European standard (ETSI, European Telecommunications Standardization Institute)
- simultaneous introduction of essential services in three phases (1991, 1994, 1996) by the European telecommunication administrations
- seamless roaming within Europe possible
- today many providers all over the world use GSM (more than 184 countries in Asia, Africa, Europe, Australia, America)
- more than 750 million subscribers
- more than 70% of mobile phones use GSM
- more than 360 billion SMS/year worldwide



Performance characteristics of GSM

- Communication
 - mobile, wireless communication; support for voice and data services
- Total mobility
 - international access, chip-card enables use of access points of different providers
- Worldwide connectivity
 - one number, the network handles localization
- High capacity
 - better frequency efficiency, smaller cells, more customers per cell
- High transmission quality
 - high audio quality and reliability for wireless, uninterrupted phone calls at higher speeds (e.g., from cars, trains)
- Security functions
 - access control, authentication via chip-card and PIN



Disadvantages of GSM

- no end-to-end encryption of user data
- no full ISDN bandwidth of 64 kbit/s to the user
- reduced concentration while driving
- electromagnetic radiation
- abuse of private data possible
- roaming profiles accessible
- high complexity of the system
- several incompatibilities within the GSM standards



GSM: Mobile Services

- GSM offers
 - several types of connections: voice connections, data connections, short message service
 - multi-service options (combination of basic services)
- Three service domains
 - Bearer Services
 - Telematic Services
 - Supplementary Services

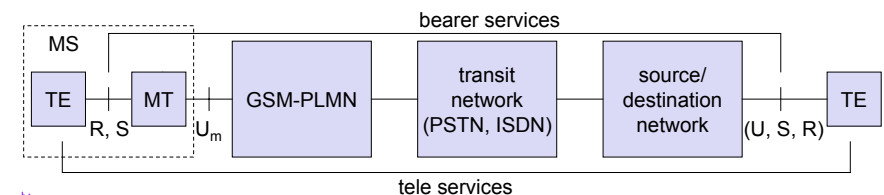

Bearer Services

- Telecommunication services to transfer data between access points
- Specification of services up to the terminal interface (OSI layers 1-3)
- Different data rates for voice and data (original standard)

- data service (circuit switched)
 - synchronous: 2.4, 4.8 or 9.6 kbit/s
 - asynchronous: 300 - 1200 bit/s

- data service (packet switched)
 - synchronous: 2.4, 4.8 or 9.6 kbit/s
 - asynchronous: 300 - 9600 bit/s



Tele Services

- Telecommunication services that enable voice communication via mobile phones
- All these basic services have to obey cellular functions, security measurements etc.

- Offered services
 - mobile telephony
primary goal of GSM was to enable mobile telephony offering the traditional bandwidth of 3.1 kHz
 - Emergency number
common number throughout Europe (112); mandatory for all service providers; free of charge, without contract; connection with the highest priority (preemption of other connections possible)



Additional Tele Services

- Non-Voice-Teleservices
 - Short Message Service (SMS)
up to 160 character alphanumeric data transmission to/from the mobile terminal using the signaling channel, thus allowing simultaneous use of basic services and SMS
 - group 3 fax
 - voice mailbox (implemented in the fixed network supporting the mobile terminals)
 - electronic mail (MHS, Message Handling System, implemented in the fixed network)
 - etc.



Supplementary services

- Services in addition to the basic services, cannot be offered stand-alone
- Similar to ISDN services besides lower bandwidth due to the radio link
- May differ between different service providers, countries and protocol versions
- Important services
 - identification: forwarding of caller number
 - suppression of number forwarding
 - automatic call-back
 - conferencing with up to 7 participants
 - locking of the mobile terminal (incoming or outgoing calls)
 - ...



GSM: overview

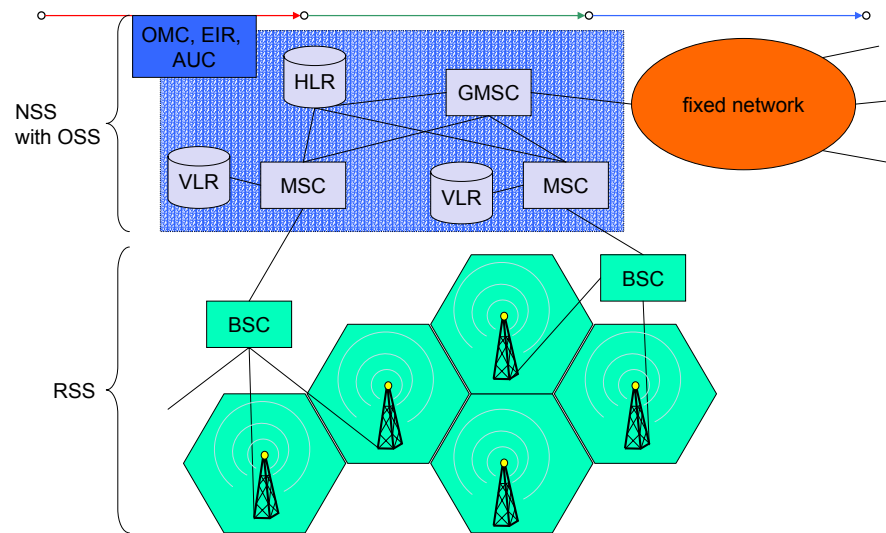

Architecture of the GSM system

- GSM is a PLMN (Public Land Mobile Network)
- several providers setup mobile networks following the GSM standard within each country
- components
 - MS (mobile station)
 - BS (base station)
 - MSC (mobile switching center)
 - LR (location register)
- subsystems
 - RSS (radio subsystem): covers all radio aspects
 - NSS (network and switching subsystem): call forwarding, handover, switching
 - OSS (operation subsystem): management of the network



GSM: elements and interfaces

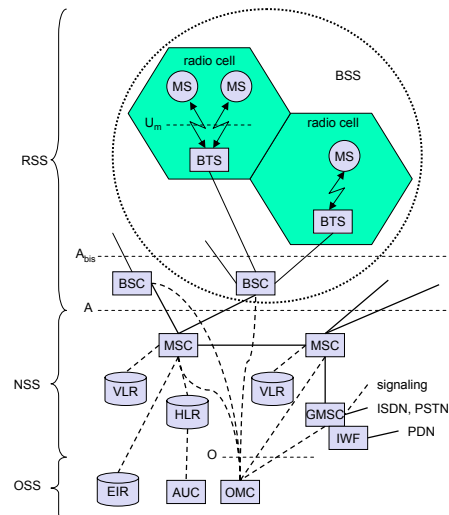

System architecture: radio subsystem

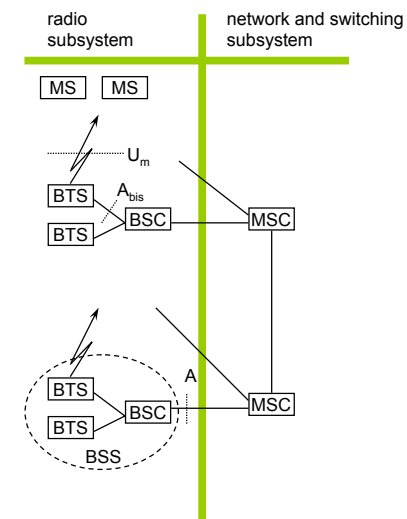

- Components
 - MS (Mobile Station)
 - BSS (Base Station Subsystem): consisting of
 - BTS (Base Transceiver Station): sender and receiver
 - BSC (Base Station Controller): controlling several transceivers
- Interfaces
 - U_m : radio interface
 - A_{bis} : standardized, open interface with 16 kbit/s user channels
 - A : standardized, open interface with 64 kbit/s user channels



Base Transceiver Station and Base Station Controller

- Tasks of a BSS are distributed over BSC and BTS
- BTS comprises radio specific functions
- BSC is the switching center for radio channels

Functions	BTS	BSC
Management of radio channels		X
Frequency hopping (FH)	X	X
Management of terrestrial channels		X
Mapping of terrestrial onto radio channels		X
Channel coding and decoding	X	
Rate adaptation	X	
Encryption and decryption	X	X
Paging	X	X
Uplink signal measurements	X	
Traffic measurement		X
Authentication		X
Location registry, location update		X
Handover management		X

[J. Schiller]



Mobile station

- Terminal for the use of GSM services
- A mobile station (MS) comprises several functional groups
 - MT (Mobile Terminal):
 - offers common functions used by all services the MS offers
 - corresponds to the network termination (NT) of an ISDN access
 - end-point of the radio interface (U_m)
 - TA (Terminal Adapter):
 - terminal adaptation, hides radio specific characteristics
 - TE (Terminal Equipment):
 - peripheral device of the MS, offers services to a user
 - does not contain GSM specific functions
 - SIM (Subscriber Identity Module):
 - personalization of the mobile terminal, stores user parameters

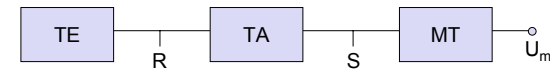

System architecture: network and switching subsystem

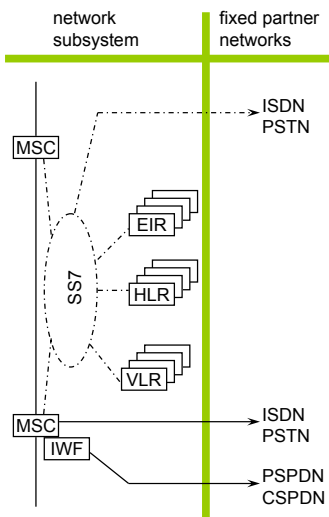

- MSC (Mobile Services Switching Center)
 - IWF (Interworking Functions)
 - ISDN (Integrated Services Digital Network)
 - PSTN (Public Switched Telephone Network)
 - PSPDN (Packet Switched Public Data Net.)
 - CSPDN (Circuit Switched Public Data Net.)
- Databases
 - HLR (Home Location Register)
 - VLR (Visitor Location Register)
 - EIR (Equipment Identity Register)



System architecture: operation subsystem

- The OSS (Operation Subsystem) enables centralized operation, management, and maintenance of all GSM subsystems
- Components
 - Operation and Maintenance Center (OMC)
 - different control capabilities for the radio subsystem and the network subsystem
 - Authentication Center (AuC)
 - generates user specific authentication parameters on request of a VLR
 - authentication parameters used for authentication of mobile terminals and encryption of user data on the air interface within the GSM system
 - Equipment Identity Register (EIR)
 - registers GSM mobile stations and user rights
 - stolen or malfunctioning mobile stations can be locked and sometimes even localized



GSM: system architecture

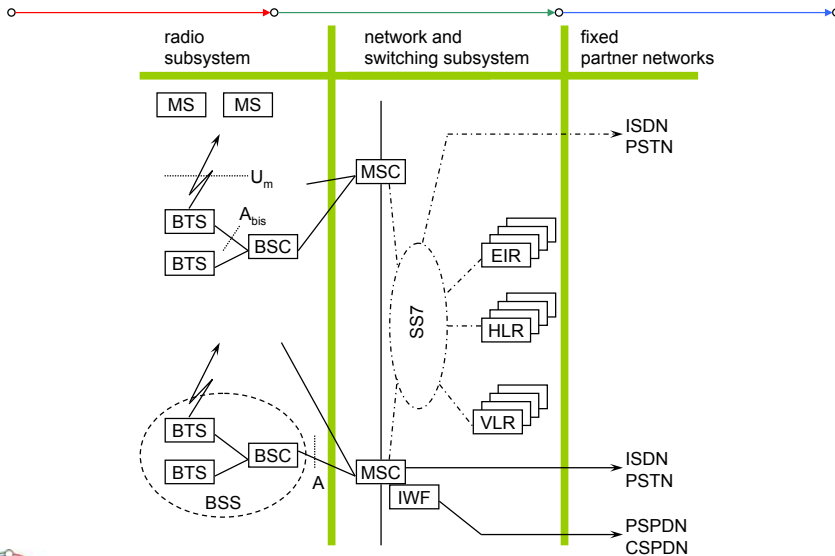

GSM: cellular network

segmentation of the area into cells

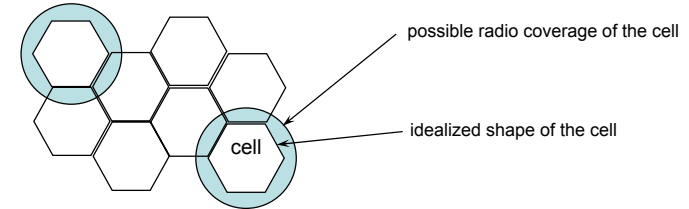

- use of several carrier frequencies
- not the same frequency in adjoining cells
- cell sizes vary from some 100 m up to 35 km depending on user density, geography, transceiver power etc.
- hexagonal shape of cells is idealized (cells overlap)
- if a mobile user changes cells:
handover of the connection to the neighbor cell



Example for space multiplexing: Cellular network

- Simplified hexagonal model
- Signal propagation ranges:
Frequency reuse only with a certain distance between the base stations
- Can you reuse frequencies in distance 2 or 3 (or more)?
- Graph coloring problem
- Example: fixed frequency assignment for reuse with distance 2
- Interference from neighbor cells (other color) can be controlled with transmit and receive filters

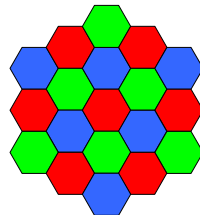
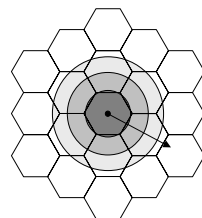

Channel Assignment

- Formal definition of the problem:
- Input: A Graph G , the nodes of G are the cells, there is an edge between two nodes if the cells interfere. Each node u has an integer weight $w(u)$ that represents the number of users in cell u .
- Output: We assign $w(u)$ colors to each node, such that no two neighboring nodes have the same color. We are interested in the minimum number of colors needed.
- This problem known as Graph Multicoloring. It is NP-hard.



Channel Assignment Variations

- Special types of graphs, e.g. the hexagon graph.
- Dynamic version: the weight of a node u is a function that changes over time: $w_t(u)$. If a future $w_t(u)$ is not known, the algorithm is online.
- Recoloring vs. non-recoloring algorithms: A dynamic algorithm is a non-recoloring algorithm if the frequency of a user is not allowed to change once it is assigned. Note that a recoloring algorithm is more powerful.
- Centralized vs. Distributed Control. In particular an algorithm is k -local if each node can only communicate with nodes within distance k .



Basic Types of Algorithms

- Fixed Assignment (FA): Nodes are partitioned into independent sets, and each such set is assigned a separate set of channels. This works very well if the traffic is balanced well. Example: Hexagon graph with reuse distance 3 is on the right.
- Borrowing Algorithms: Improvement of FA. If traffic is not balanced, cells can borrow frequencies from neighboring cells.
- Hybrid Channel Assignment: Divide the frequencies into “reserved” and “borrowable” ones.
- Dynamic Channel Assignment: A centrally coordinated pool of frequencies is distributed to cells.

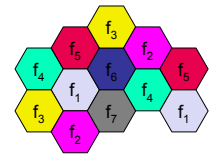

Online Channel Assignment

- Problem: We are given the hexagon graph with reuse distance 2. Callers arrive at cells in online fashion, that is, one after the other in an input sequence σ . We need to give each caller a channel (an integer), such that no caller in the same or a neighboring hexagon has the same channel. We assume that calls have infinite duration (which is the same as assuming that all calls have the same duration).
- Cost: The cost of the algorithm is the value of the highest channel we used.
- Competitive Analysis: If $\text{cost}_{\text{ALG}}(\sigma) \leq \rho \cdot \text{cost}_{\text{OPT}}(\sigma) + \text{const}$ for all input sequences σ and an optimal offline algorithm OPT, then the Algorithm ALG is called ρ -competitive. (Note: if $\text{const} = 0$ the ALG is *strictly* ρ -competitive.)



The Greedy Algorithm for Online Channel Assignment

- Algorithm: When a new call arrives, it is assigned the minimum available channel, that is, the minimum integer that is not used in the cell and the neighboring cells.
- Theorem: The Greedy Algorithm is 2.5-competitive. This is optimal.
- Unfortunately, both upper bound and lower bound are too intricate to be presented here. But we can easily show that
- Theorem for lazy professors: The Greedy Algorithm is 3-competitive.



Wait a minute...

- So far: If two antennas “overlap” they are assigned different frequencies.
- Is this really true? Check this example with 3 antennas

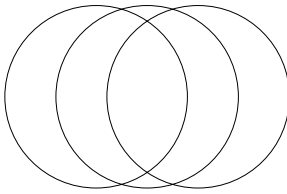

- You may assign the two outer antennas the same frequency!



Online Call Control

- Problem: In a real GSM network, we have only a fixed amount of channels available. If there are more callers, we have to reject some.
- Simplification: We have only 1 frequency available.
- Problem Statement: We are given the hexagon graph with reuse distance 2. Callers arrive at cells in online fashion, that is, one after the other in an input sequence σ . We need to accept or reject each caller, such that there is at most 1 caller in a cell and its 6 neighboring cells. We assume that calls have infinite duration (which is the same as assuming that all calls have the same duration).
- Benefit: The benefit of the algorithm is the number of callers we accept.
- Competitive Analysis: If $\rho \cdot \text{benefit}_{\text{ALG}}(\sigma) \geq \text{benefit}_{\text{OPT}}(\sigma)$ for all input sequences σ and an optimal offline algorithm OPT, then the Algorithm ALG is called ρ -competitive.



The Greedy Algorithm for Online Call Control

- Algorithm: When a new call arrives, it is accepted whenever possible.
- Theorem: The Greedy Algorithm is 3-competitive.
- Problem of algorithm is obvious already with the first call: If we do not accept the call, we are not at all competitive (because it might be the only call); if we accept the call might have to discard 3 calls in the neighboring calls later.

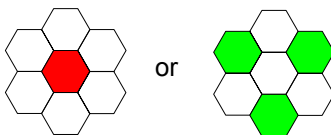

A Randomized Algorithm for Online Call Control

- It was long believed that the greedy algorithm is the best possible.
- New idea: Maybe randomization helps. Don't accept every call that you might accept.
- Problem: Maybe adversary presents the same cell over and over until we (randomly) accept and then presents the 3 callers in the neighboring cells.
- Solution: If once a caller was (randomly) rejected in a cell, we should not accept any caller anymore in this cell (we mark the cell).



A Randomized Algorithm for Online Call Control

- Algorithm: Initially, all cells are unmarked.
- For a new call in cell u :
 - If u is marked or a call in $N^*(u)$ is accepted, then we reject the call.
 - Else: With probability p , we accept the call.
 - With probability $1-p$, we reject the call and mark the cell u .
- Theorem: The randomized algorithm is 2.97-competitive.
- Remarks:
 - For randomized algorithms, we use the expected benefit.
 - An improved version of the algorithm is 2.651-competitive.
 - The algorithm can be generalized and is $27/28 \cdot \Delta$ -competitive.



GSM - TDMA/FDMA

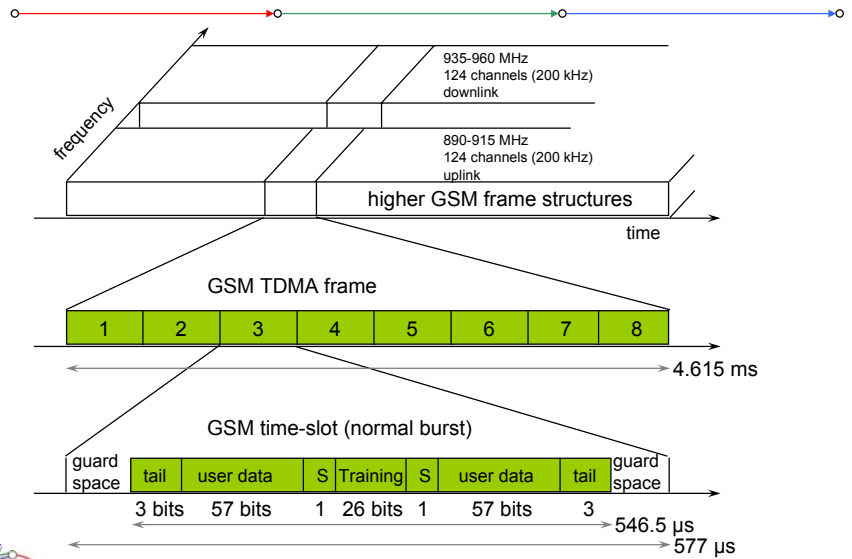

Logical Channels

- Traffic Channel TCH: For speech and data
 - Full rate TCH/F (22.8 kbit/s), Half rate TCH/H (11.8 kbit/s)
 - Speech codec needed 13 kbit/s – remaining bandwidth is used for strong error correction TCH/FS; now some use TCH/HS
 - For data there are TCH/F4.8, TCH/F9.6, and TCH/F14.4
- Control Channel CCH
 - Broadcast Control Channel BCCH: global variables in cell (such as hopping scheme, frequencies, frequencies of neighbor cells, etc.)
 - Frequency Correction Channel FCCH, Synchronization Channel SCH
 - Common Control Channel CCCH
 - Paging Channel PCH, Random Access Channel RACH (slotted Aloha!)
 - Dedicated Control Channel DCCH: Bidirectional
 - Stand-alone Dedicated Control Channel SDCCH (for stations without TCH, with only 782 bit/s), Slow Associated Dedicated Control Channel SACCH (for each station), Fast Associated Dedicated Control Channel FACCH (in case of handover)



GSM hierarchy of frames

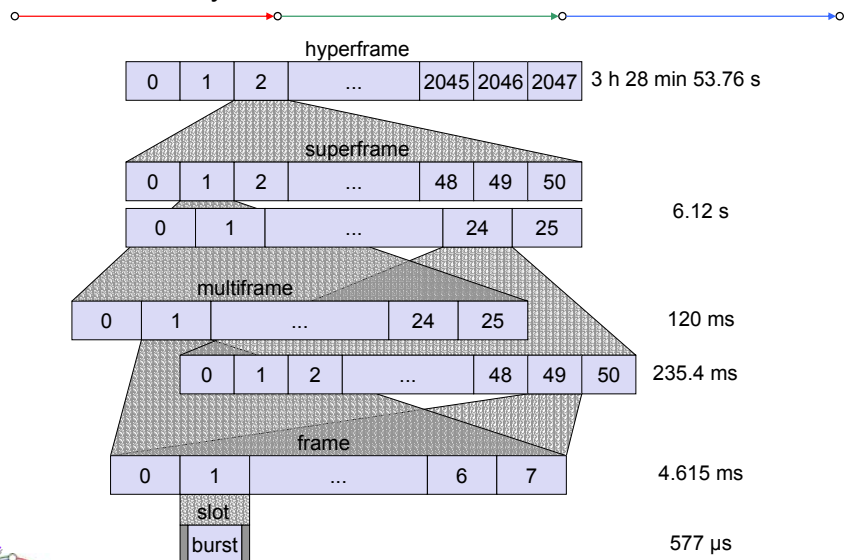

GSM protocol layers for signaling

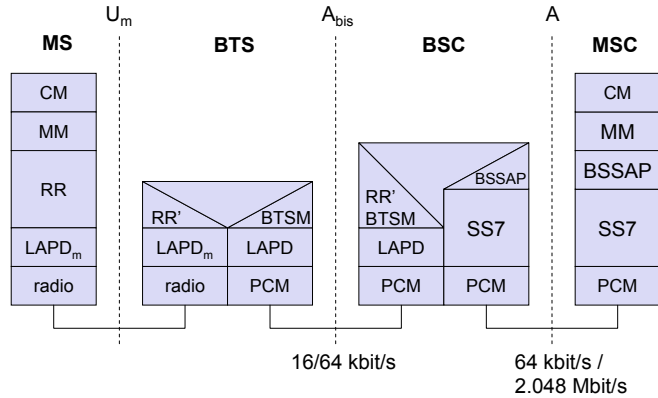

Mobile Terminated Call

- calling a GSM subscriber
- forwarding call to GMSC
- signal call setup to HLR
- 5: request MSRN from VLR
- 6: forward responsible MSC to GMSC
- 7: forward call to current MSC
- 8, 9: get current status of MS
- 10, 11: paging of MS
- 12, 13: MS answers
- 14, 15: security checks
- 16, 17: set up connection

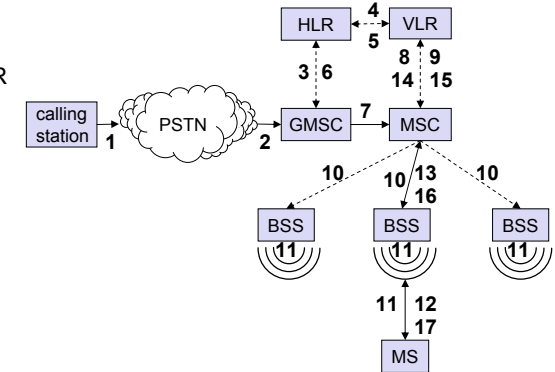

Mobile Originated Call

- 1, 2: connection request
- 3, 4: security check
- 5-8: check resources (free circuit)
- 9-10: set up call

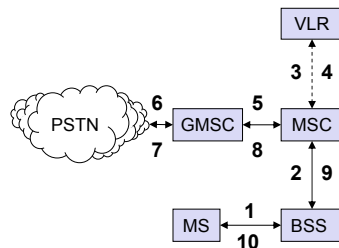

MTC/MOC

