



Discrete Event Systems

Exercise Sheet 11

1 Token Game

- a) In this example, it is easy to enumerate all possible markings in order to disprove the claim. As an alternative, note that the sum of tokens at the places a, e, d, and f is always at most 1: place e gets only a token if place a loses a token, place d gets only a token if place e loses a token, and similarly for places f and d and a and f.
- b) Starting with $[a, c]$ and performing all possible transitions yields the following possible markings: $[a, c], [b, e, c], [d, b], [b, f, c]$. The number of markings is clearly finite.

2 Calculating with Petri Nets

a) $f_1(x, y) = 5x + y:$

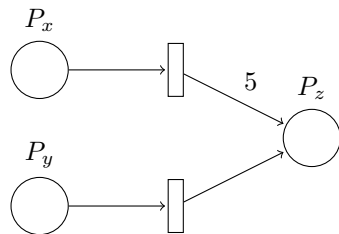

b) $f_2(x, y) = x - 2y:$

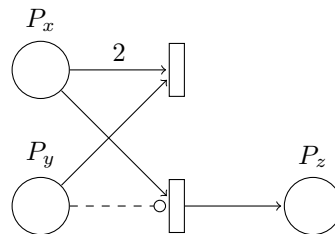

c) $f_3(x, y) = x \cdot y:$

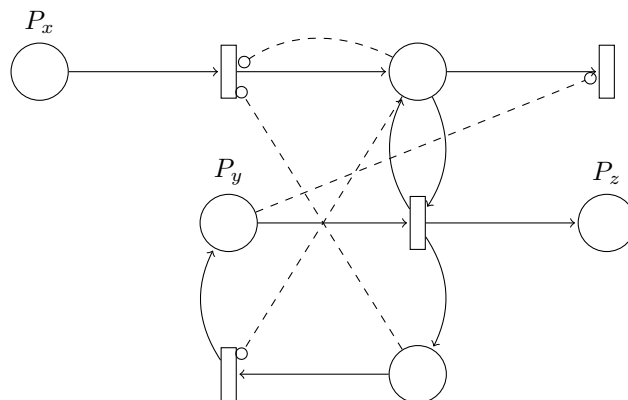

3 Petri Net Languages

- a) Whenever a 0 is entered, a token is added to the place left of the transition for 1 and also to the starting place. The 1-transition will fire exactly as often as the 0-transition, but it cannot fire until the starting place is empty – which is ensured by the inhibitor arc. The ϵ -transition to the left can be used to either generate a word of length 0 or to end the generation of zeroes.

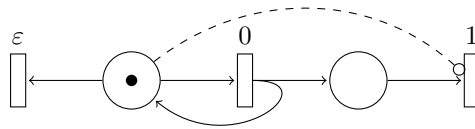

- b) The top-part of the PN generates zeroes, the bottom-part generates ones. It seems as if the number of ones and zeroes is independent, since both transitions can fire independently. However, look at the top-right ϵ -transition: It can fire as long as there is a token in the place left of it, meaning it is not “dead” until there are no tokens in the place left of it. But these tokens can only be destroyed by the bottom-right ϵ -transition, which requires a token as well from the place left of it. In other words: For each zero-transition fired, we also need to fire a one-transition.

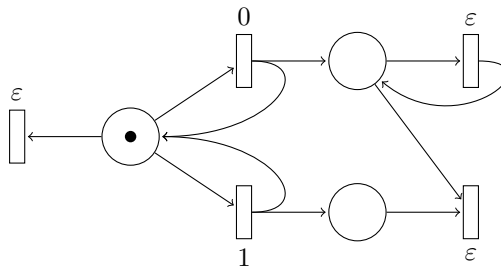

4 A Candlelight Dinner

- a) (i) The following figure shows a possible solution with three places: Either Alice has the spoon, or Bob, or the spoon lies on the table.

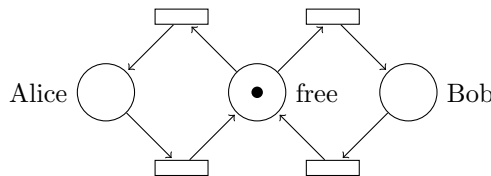

- (ii) The claim follows directly from the finite state transition graph:

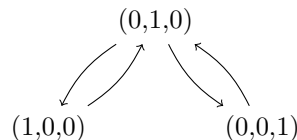

- (iii) If Alice and Bob strictly alternate, the petri net looks as follows:

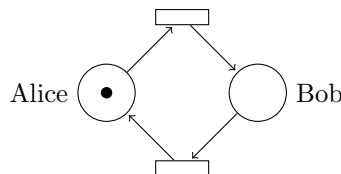

- b) The situation could be modelled as shown in the following figure. Note that the petri net is symmetric, since Alice (petri net on the left) and Bob (petri net on the right) behave in the same way. Thereby, AF denotes that Alice has the fork and eats veggies, AS denotes that Alice has the spoon and eats veggies, and the place AFS denotes that Alice uses both fork and spoon to eat spaghetti. BF, BS, and BFS are the corresponding places of Bob. Finally, the place “fork” (or “spoon”) means that the fork (or spoon) is free.

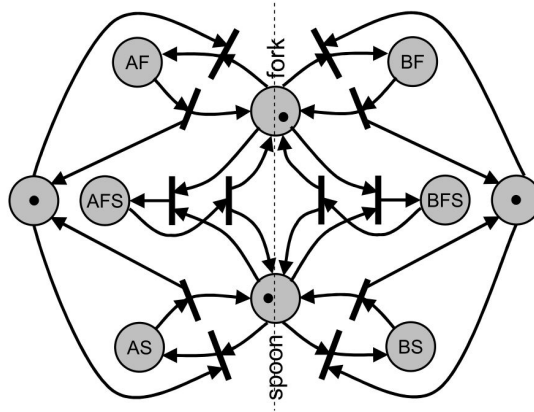

- c) The additional fork can be taken into account by adding a token to the place “fork free”. However, we have to make sure that neither Alice nor Bob has two forks at the same time. This requires two additional transitions as shown in the figure.

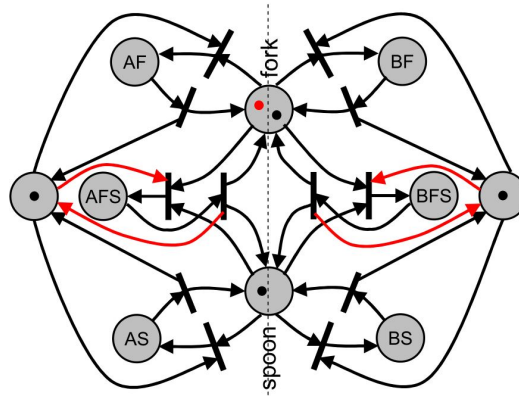

- d) The petri net now looks as follows:

