

Chapter 2

PHYSICAL AND

LINK LAYER

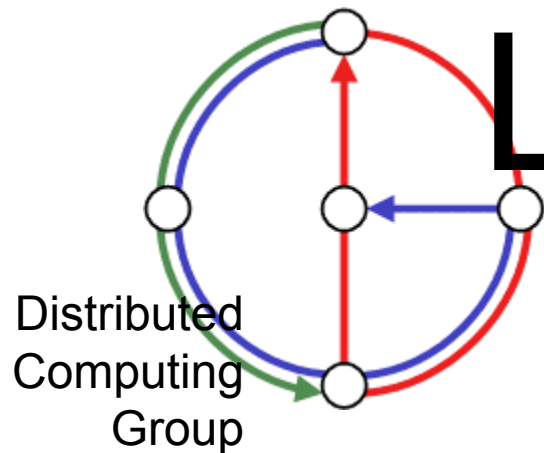

Mobile Computing
Summer 2002

Overview



- Frequencies
- Electromagnetic waves
- Antenna
- Modulation
- Signal propagation

- Multiplexing
- Spread spectrum
- CDMA

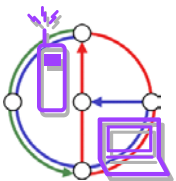

Frequencies

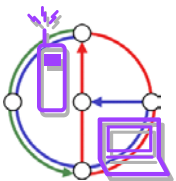
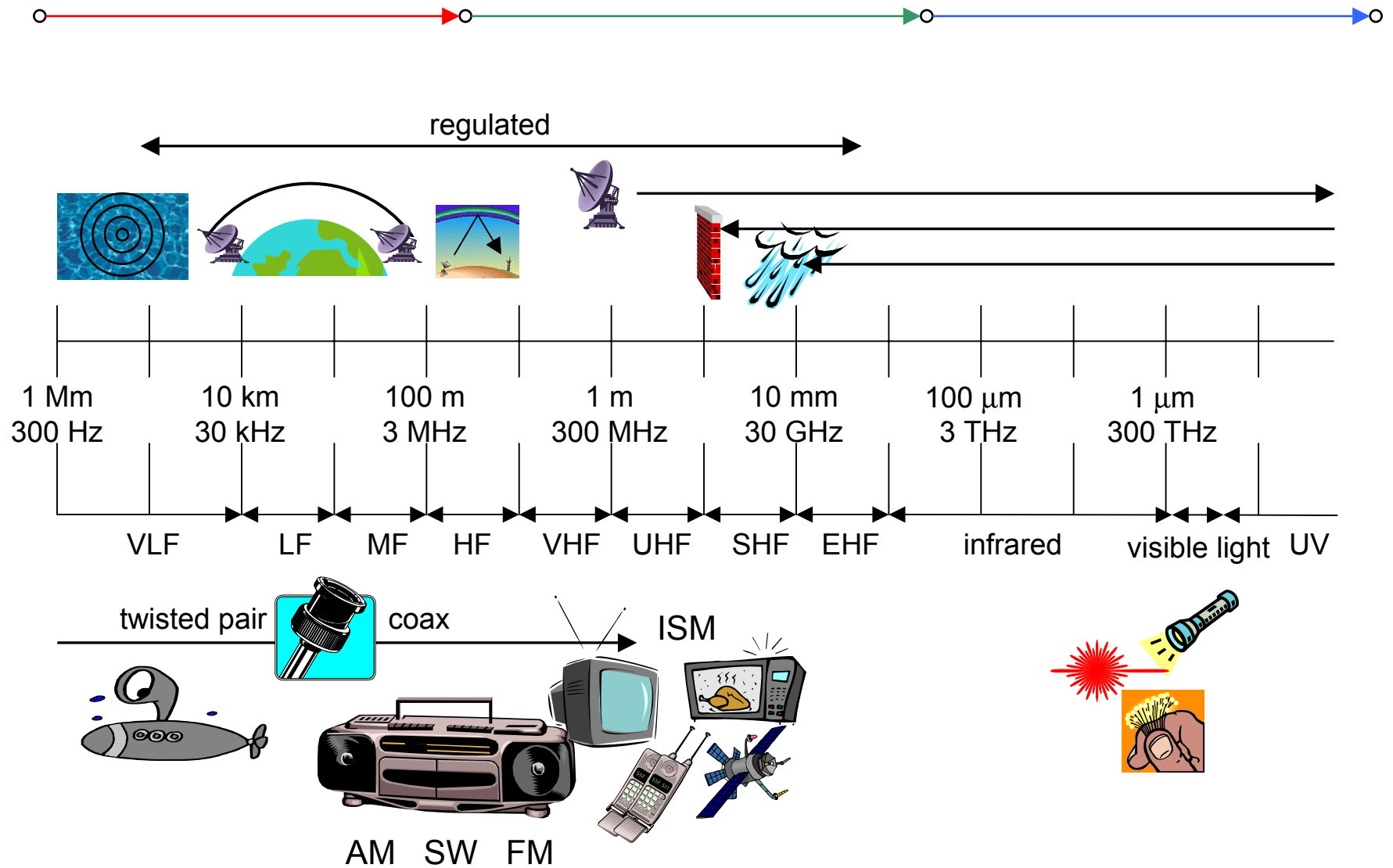

Frequencies and regulations

- ITU-R holds auctions for new frequencies, manages frequency bands worldwide (WRC, World Radio Conferences)

	Europe (CEPT/ETSI)	USA (FCC)	Japan
Mobile phones	NMT 453-457MHz, 463-467 MHz GSM 890-915 MHz, 935-960 MHz, 1710-1785 MHz, 1805-1880 MHz	AMPS, TDMA, CDMA 824-849 MHz, 869-894 MHz TDMA, CDMA, GSM 1850-1910 MHz, 1930-1990 MHz	PDC 810-826 MHz, 940-956 MHz, 1429-1465 MHz, 1477-1513 MHz
Cordless telephones	CT1+ 885-887 MHz, 930-932 MHz CT2 864-868 MHz DECT 1880-1900 MHz	PACS 1850-1910 MHz, 1930-1990 MHz PACS-UB 1910-1930 MHz	PHS 1895-1918 MHz JCT 254-380 MHz
Wireless LANs	IEEE 802.11 2400-2483 MHz HIPERLAN 1 5176-5270 MHz	IEEE 802.11 2400-2483 MHz	IEEE 802.11 2471-2497 MHz

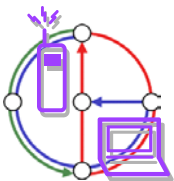

Electromagnetic waves



- $g(t) = A_t \sin(2\pi f_t t + \varphi_t)$
- Amplitude A
- frequency f [Hz = 1/s]
- period $T = 1/f$
- wavelength λ
with $\lambda f = c$
($c=3 \cdot 10^8$ m/s)
- phase φ
- $\varphi^* = -\varphi T/2\pi$ [+T]

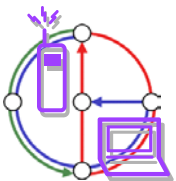
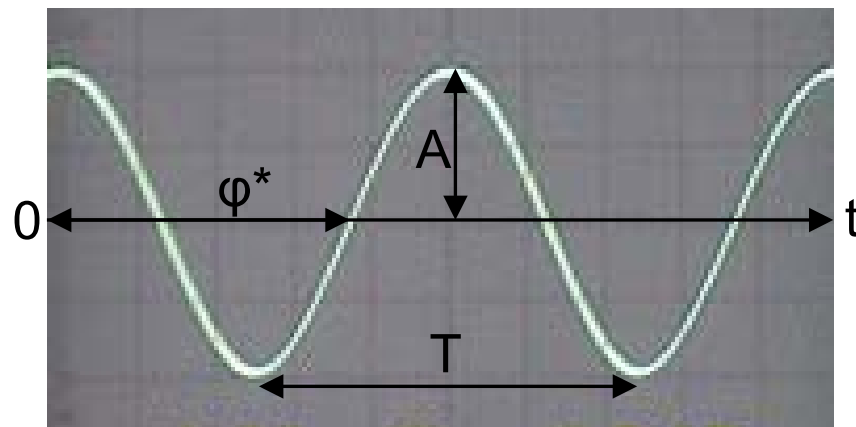

Transmitting digital data: Fourier?



- Every (periodic) signal can be represented by infinitely many sines and cosines

$$g(t) = \frac{1}{2}c + \sum_{n=1}^{\infty} a_n \sin(2\pi nft) + \sum_{n=1}^{\infty} b_n \cos(2\pi nft)$$

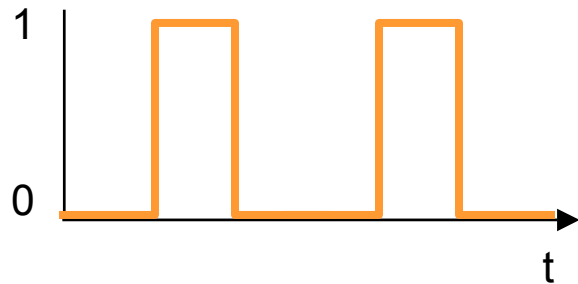

periodic signal

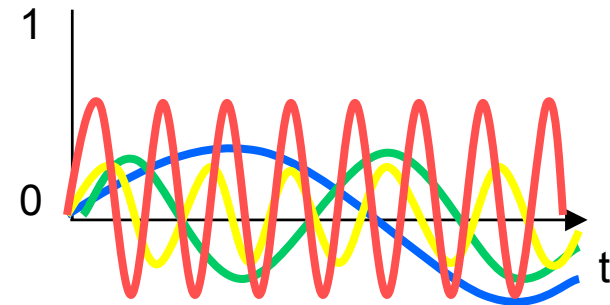

superpose harmonics

- But in wireless communication we only have narrow bands
- Also different frequencies behave differently
- Modulation

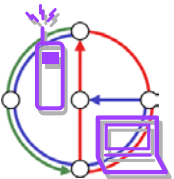

Antennas: isotropic radiator



- Radiation and reception of electromagnetic waves, coupling of wires to space for radio transmission
- Isotropic radiator: equal radiation in all three directions
- Only a theoretical reference antenna
- Radiation pattern: measurement of radiation around an antenna
- Sphere: $S = 4\pi r^2$

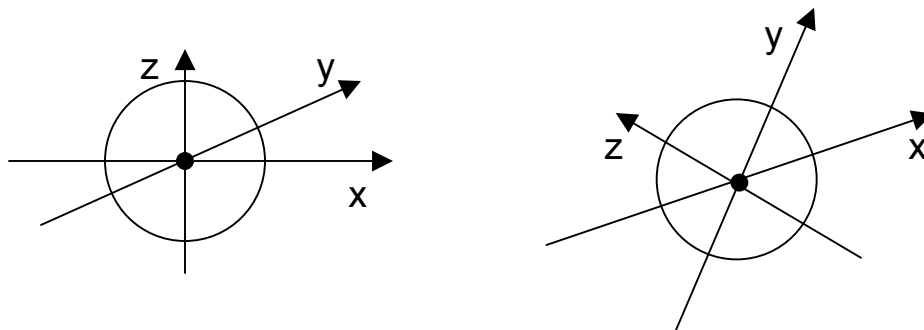

ideal
isotropic
radiator

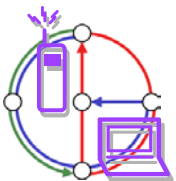

Antennas: simple dipoles



- Real antennas are not isotropic radiators but, e.g., dipoles with lengths $\lambda/2$ as Hertzian dipole or $\lambda/4$ on car roofs or shape of antenna proportional to wavelength

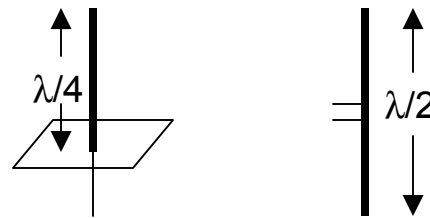

- Example: Radiation pattern of a simple Hertzian dipole

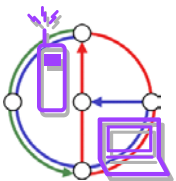
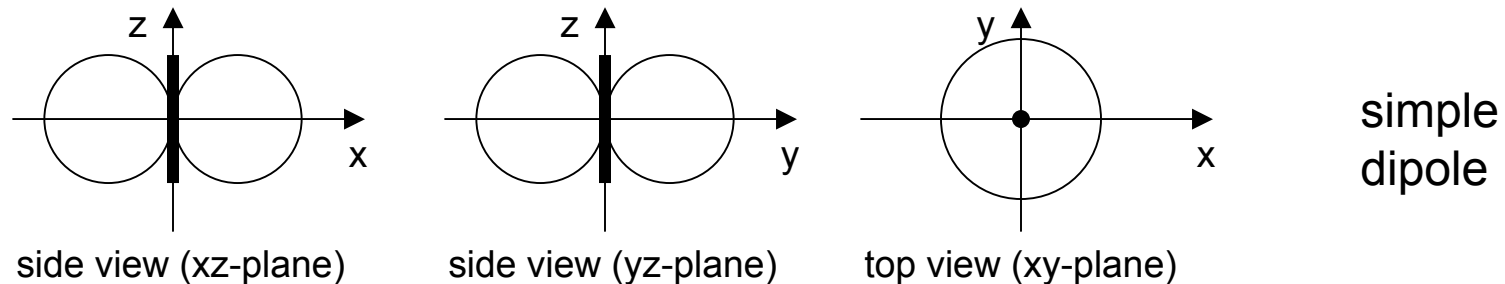

Antennas: directed and sectorized

- Often used for microwave connections or base stations for mobile phones (e.g., radio coverage of a valley)

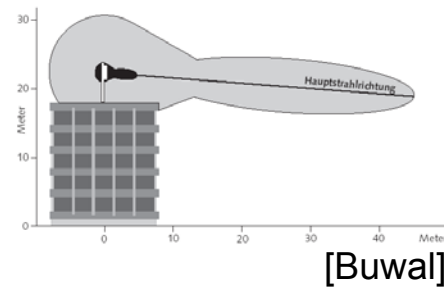
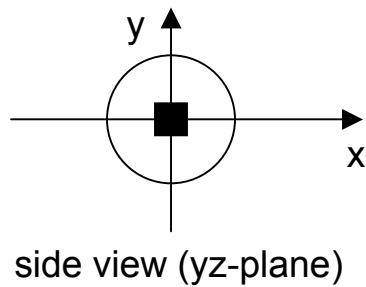
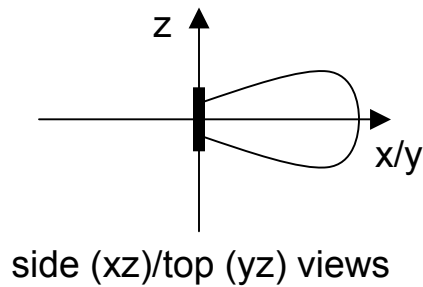

directed antenna

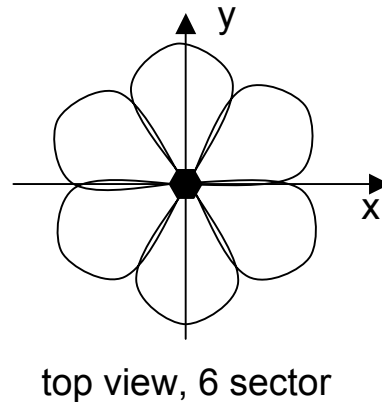
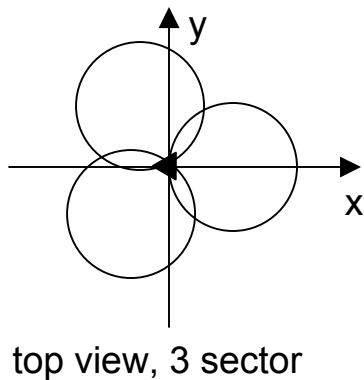

sectorized antenna

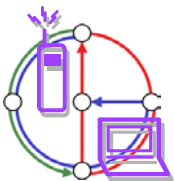

Antennas: diversity



- Grouping of 2 or more antennas
 - multi-element antenna arrays
- Antenna diversity
 - switched diversity, selection diversity
 - receiver chooses antenna with largest output
 - diversity combining
 - combine output power to produce gain
 - cophasing needed to avoid cancellation

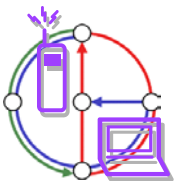
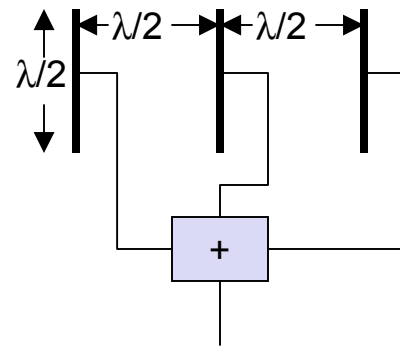
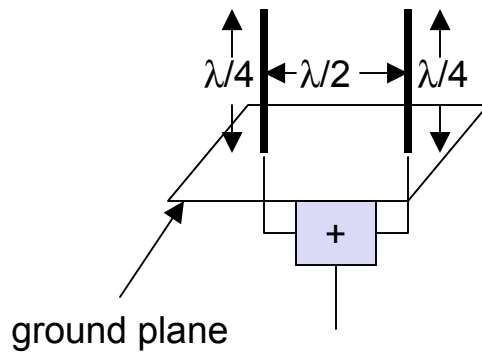

Signal propagation ranges



- Propagation in free space always like light (straight line)
- Transmission range
 - communication possible
 - low error rate
- Detection range
 - detection of the signal possible
 - no communication possible
- Interference range
 - signal may not be detected
 - signal adds to the background noise

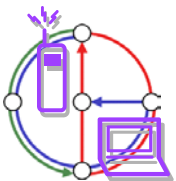
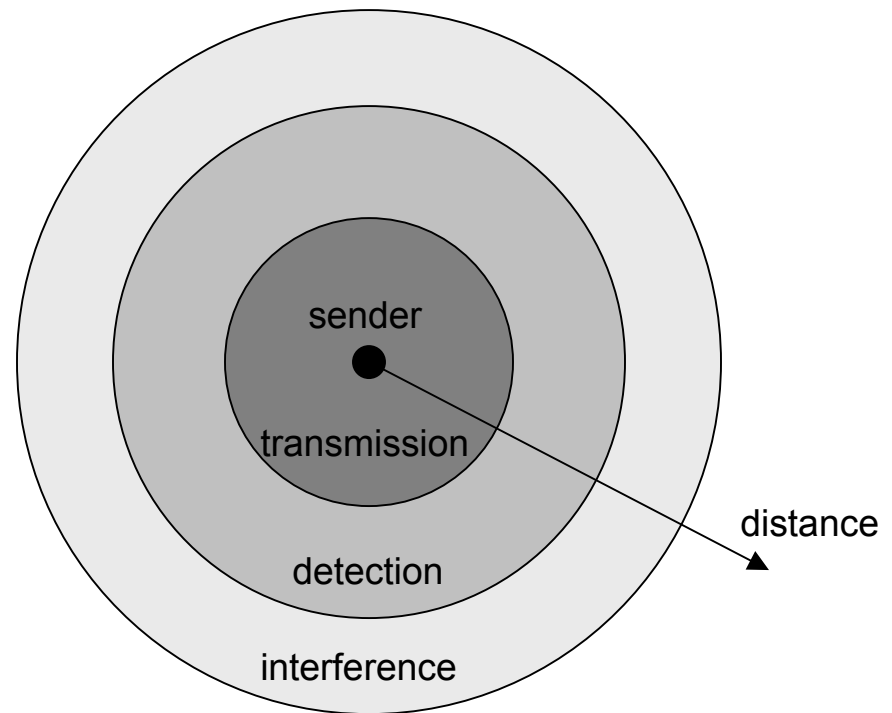

Attenuation by distance



- Attenuation [dB] = $10 \log_{10}$ (transmitted power / received power)
- Example: factor 2 loss = $10 \log_{10} 2 \approx 3$ dB
- In theory/vacuum (and for short distances), receiving power is proportional to $1/d^2$, where d is the distance.
- In practice (for long distances), receiving power is proportional to $1/d^\alpha$, $\alpha = 4 \dots 6$. We call α the path loss exponent.
- Example: Short distance, what is the attenuation between 10 and 100 meters distance?
Factor 100 ($=100^2/10^2$) loss = 20 dB

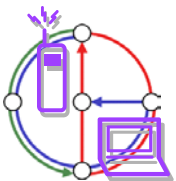
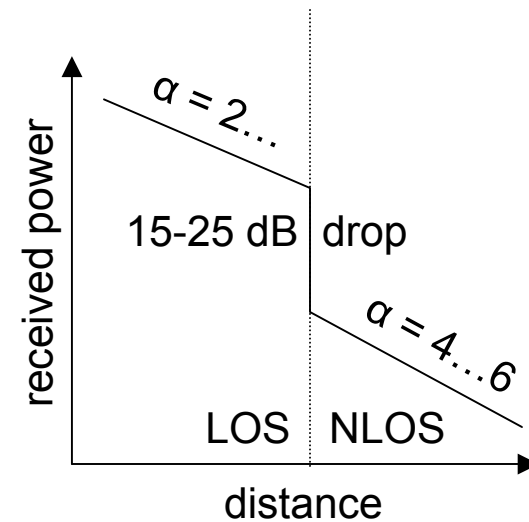

Attenuation by objects



- Shadowing (3-30 dB):
 - textile (3 dB)
 - concrete walls (13-20 dB)
 - floors (20-30 dB)
- reflection at large obstacles
- scattering at small obstacles
- diffraction at edges
- fading (frequency dependent)

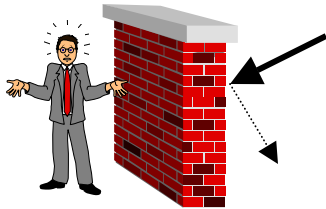

shadowing

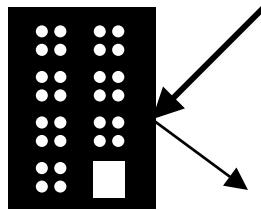

reflection



scattering



diffraction

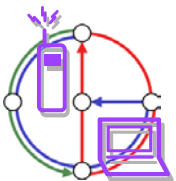

Multipath propagation



- Signal can take many different paths between sender and receiver due to reflection, scattering, diffraction

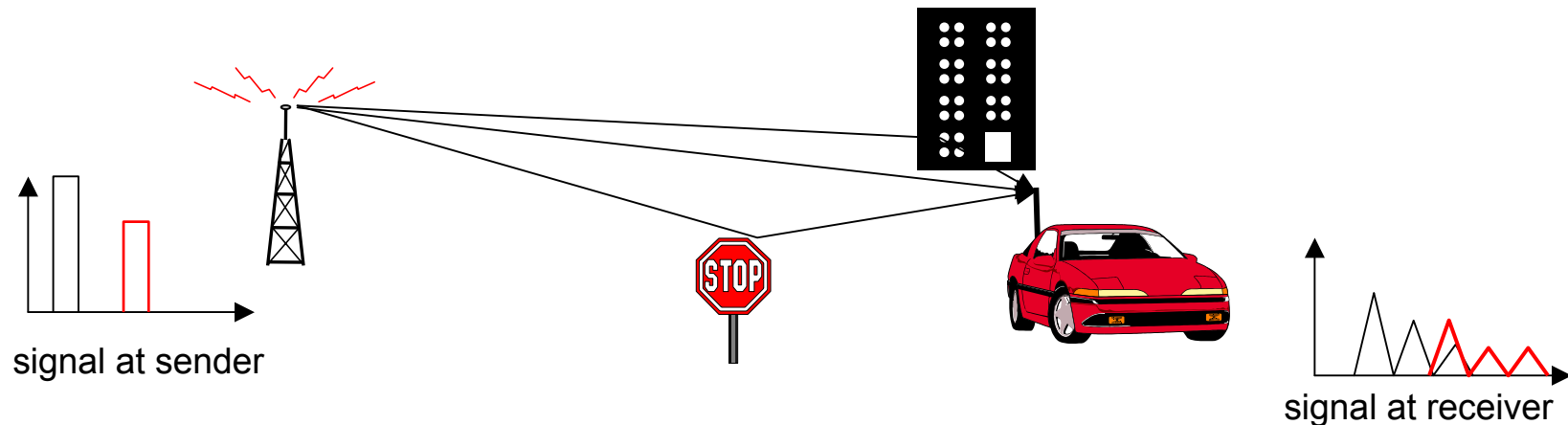

- Time dispersion: signal is dispersed over time
- Interference with “neighbor” symbols: Inter Symbol Interference (ISI)
- The signal reaches a receiver directly and phase shifted
- Distorted signal depending on the phases of the different parts

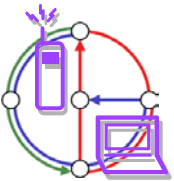

Effects of mobility



- Channel characteristics change over time and location
 - signal paths change
 - different delay variations of different signal parts
 - different phases of signal parts
- quick changes in power received (short term fading)
- Additional changes in
 - distance to sender
 - obstacles further away
- slow changes in average power received (long term fading)
- Doppler shift: Random frequency modulation

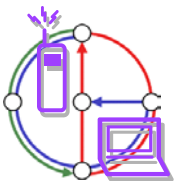
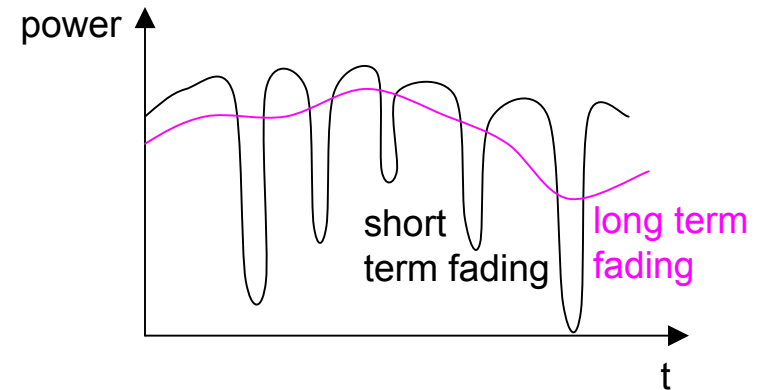

Multiplexing



- Multiplex channels (k) in four dimensions
 - space (s)
 - time (t)
 - frequency (f)
 - code (c)
- Goal: multiple use of a shared medium
- Important: guard spaces needed!
- Example: radio broadcast

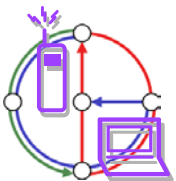
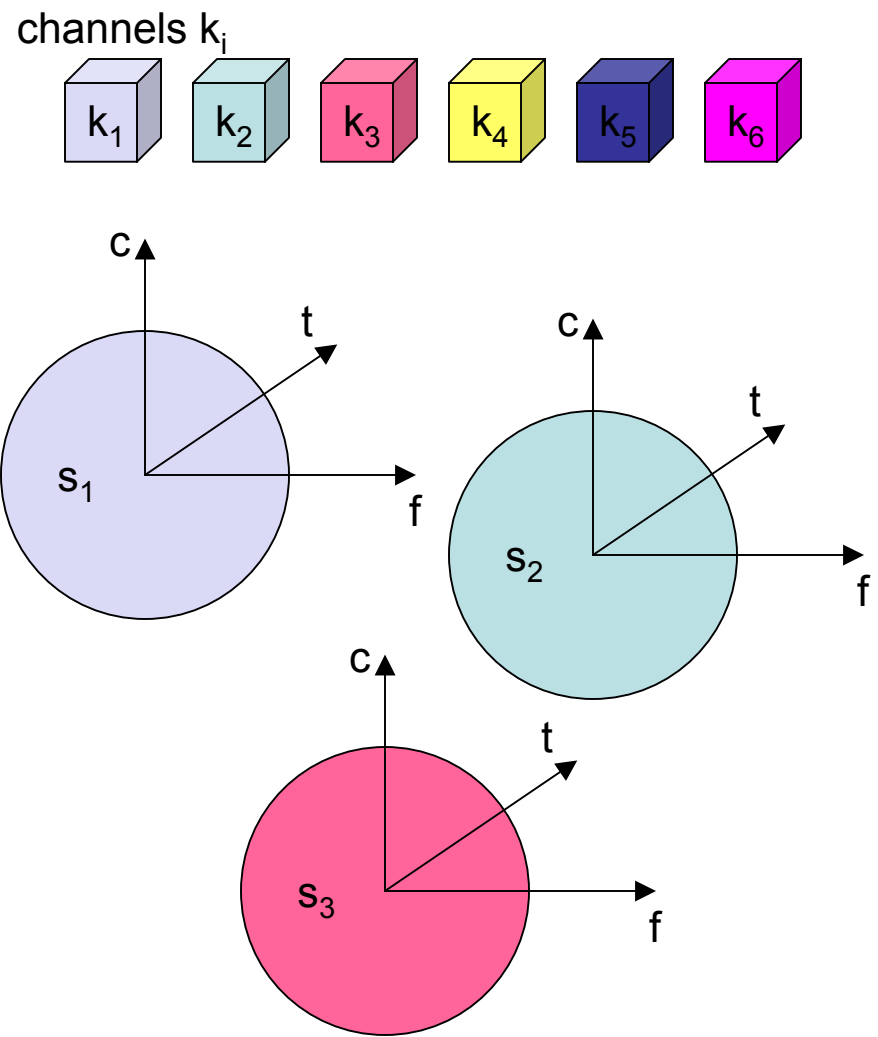

Example for space multiplexing: Cellular network



- Simplified hexagonal model
- Signal propagation ranges:
Frequency reuse only with a certain distance between the base stations
- Can you reuse frequencies in distance 2 or 3 (or more)?
- Graph coloring problem
- Example: fixed frequency assignment for reuse with distance 2
- Interference from neighbor cells (other color) can be controlled with transmit and receive filters

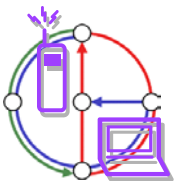
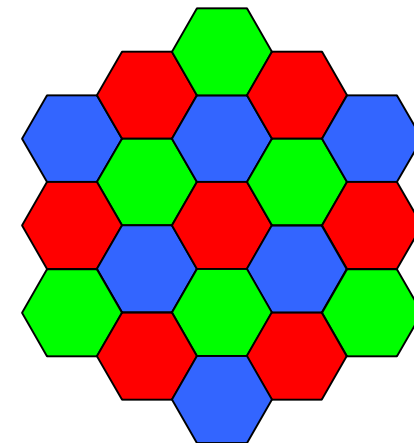
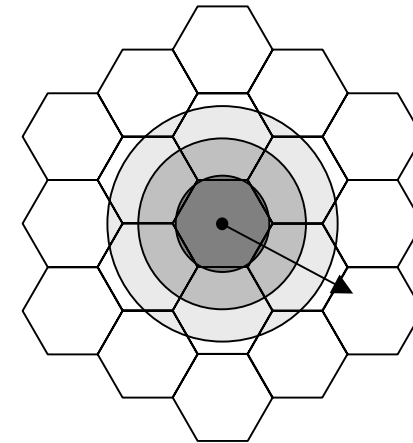

Carrier-to-Interference / Signal-to-Noise



- Digital techniques can withstand a Carrier-to-Interference ratio of approximately 9 dB.
- Assume the path loss exponent $\alpha = 3$. Then,

$$\frac{C}{I} = \frac{(D - R)^\alpha}{R^\alpha} = \left(\frac{D}{R} - 1\right)^\alpha$$

which gives $D/R = 3$. Reuse distance of 2 might just work...

- Remark: Interference that cannot be controlled is called *noise*. Similarly to C/I there is a signal-to-noise ratio S/N (SNR).

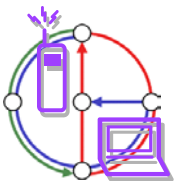
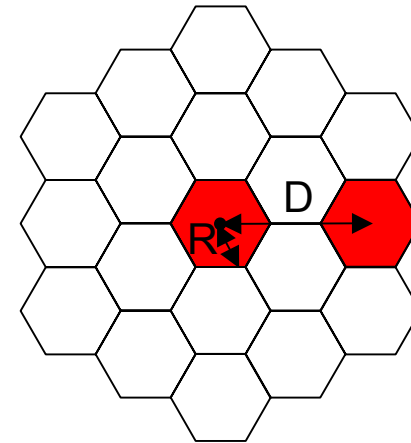

Frequency Division Multiplex (FDM)



- Separation of the whole spectrum into smaller frequency bands
- A channel gets a certain band of the spectrum for the whole time
- + no dynamic coordination necessary
- + works also for analog signals
- waste of bandwidth if traffic is distributed unevenly
- inflexible
- Example: broadcast radio

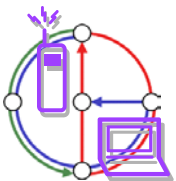
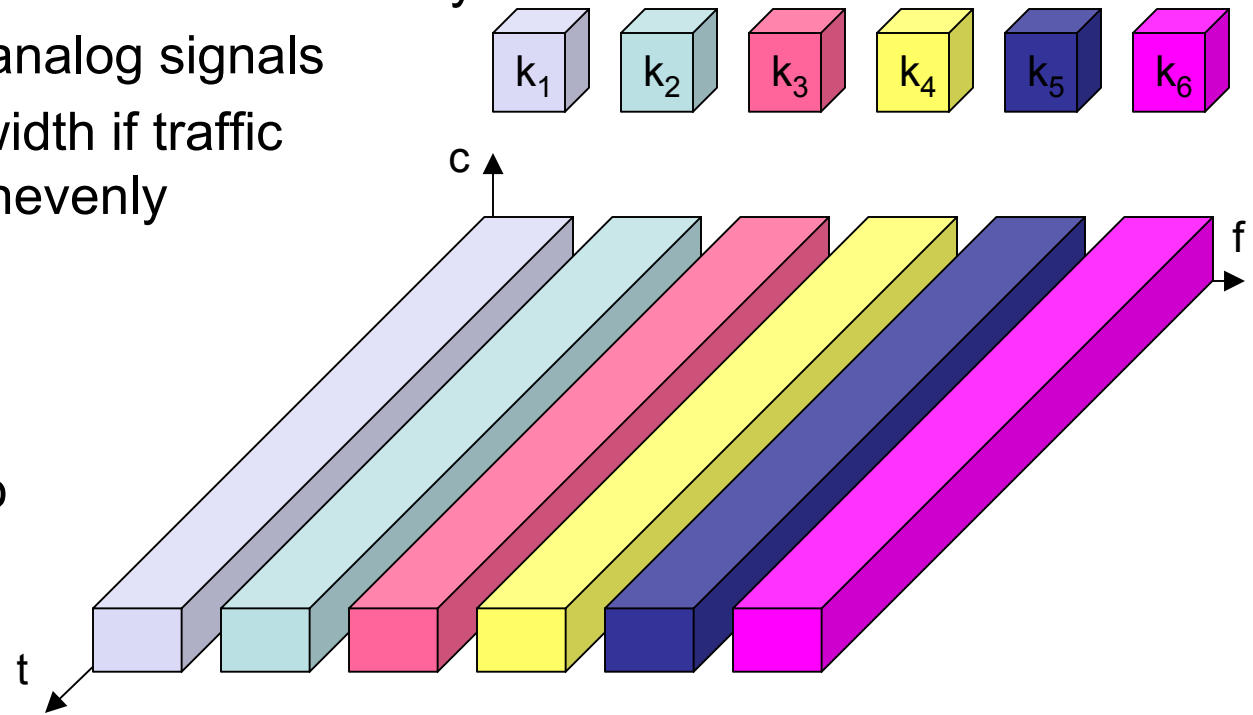

Time Division Multiplex (TDM)



- A channel gets the whole spectrum for a certain amount of time
- + only one carrier in the medium at any time
- + throughput high even for many users
- precise synchronization necessary

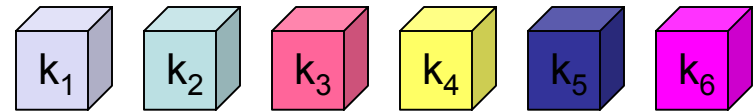

- Example: Ethernet

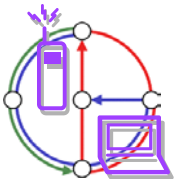
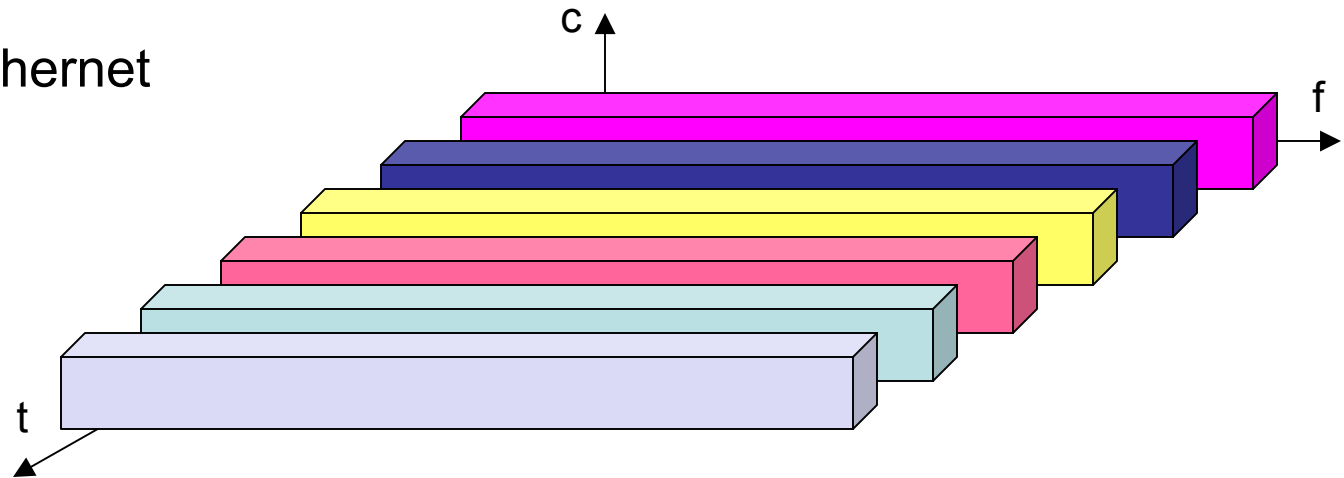

Time and Frequency Division Multiplex



- Combination of both methods
- A channel gets a certain frequency band for some time
- + protection against frequency selective interference
- + protection against tapping
- + adaptive
- precise coordination required

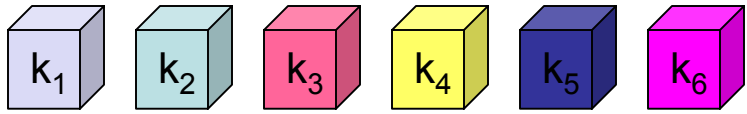

- Example: GSM

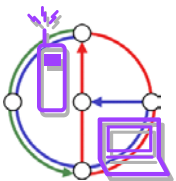
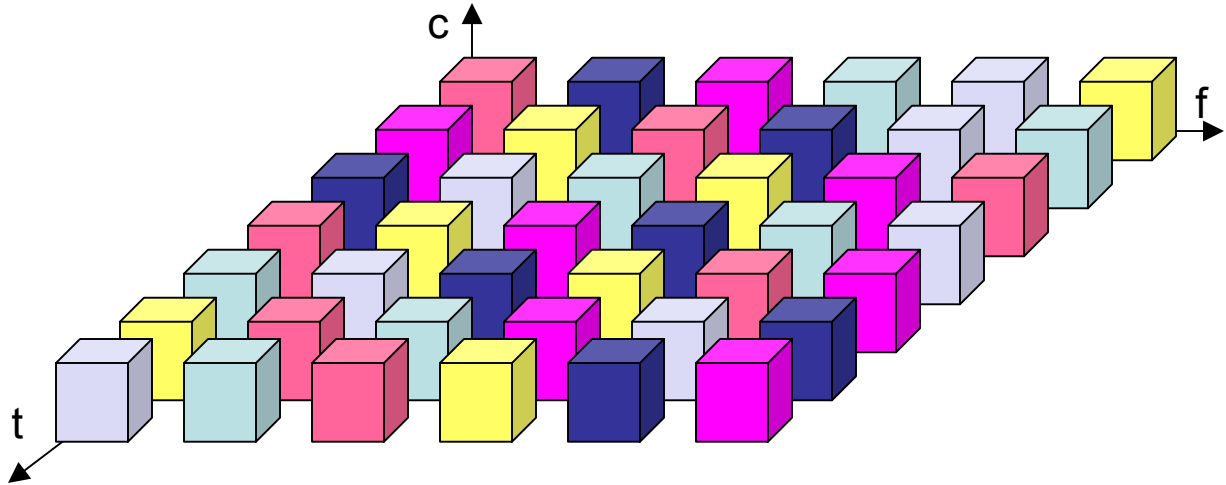

Code Division Multiplex (CDM)

- Each channel has a unique code
- All channels use the same spectrum at the same time
- + bandwidth efficient
- + no coordination or synchronization
- + hard to tap
- + almost impossible to jam
- lower user data rates
- more complex signal regeneration
- Example: UMTS
- Spread spectrum
- U. S. Patent 2'292'387, Hedy K. Markey (a.k.a. Lamarr or Kiesler) and George Antheil (1942)

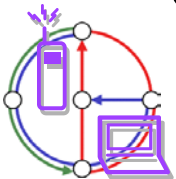
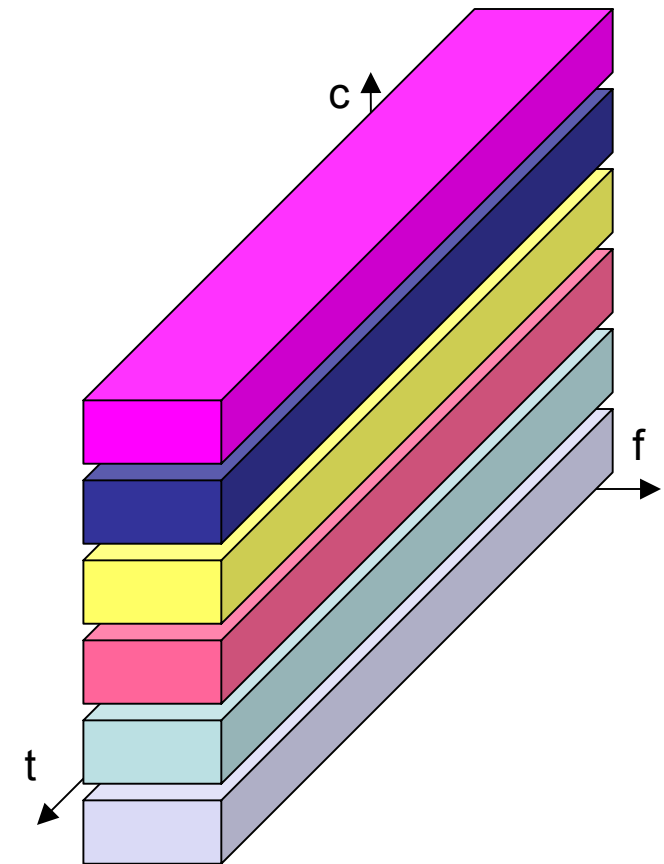
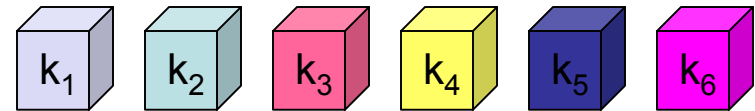

Cocktail party as analogy for multiplexing



- Space multiplex: Communicate in different rooms
- Frequency multiplex: Use soprano, alto, tenor, or bass voices to define the communication channels
- Time multiplex: Let other speaker finish
- Code multiplex: Use different languages and hone in on your language. The “farther apart” the languages the better you can filter the “noise”: German/Japanese better than German/Dutch. Can we have orthogonal languages?

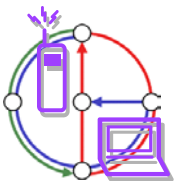
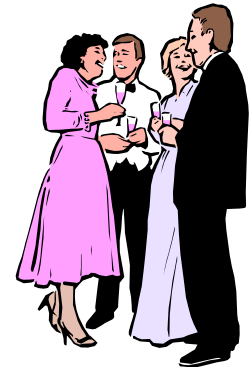

Spread spectrum technology



- Problems: narrowband interference and frequency dependent fading
- Solution: spread the narrow band signal into a broad band signal using a special code

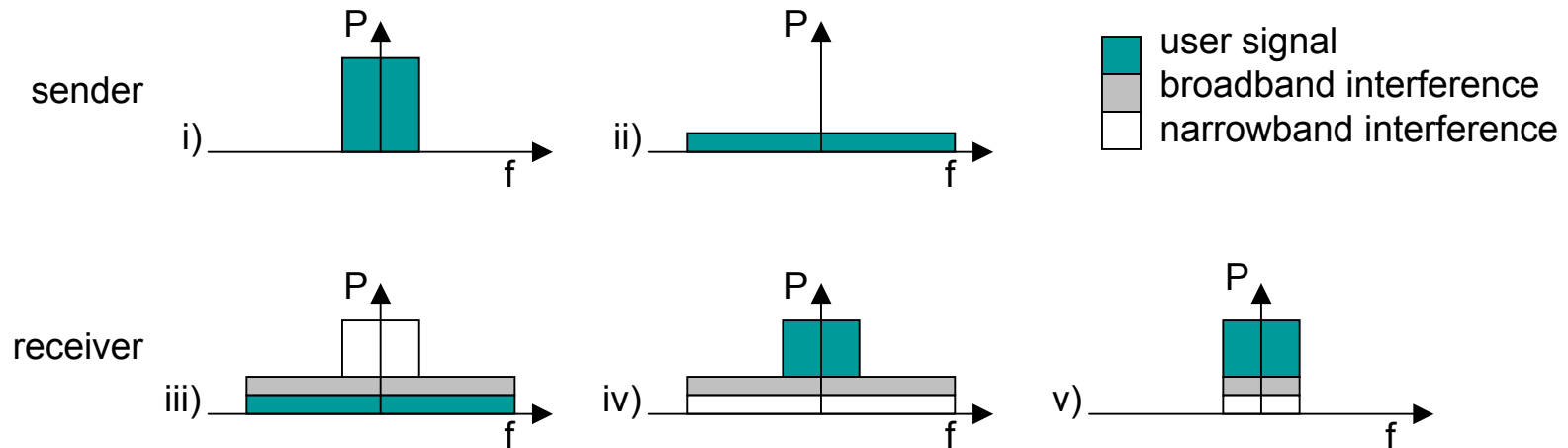

- Side effects: co-existence of several signals, and more tap-proof
- Implementations: Frequency Hopping or Direct Sequence

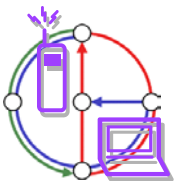

Frequency Hopping Spread Spectrum (FHSS)



- Discrete changes of carrier frequency
 - sequence of frequency changes determined via pseudo random number sequence
- Two variants
 - Fast Hopping: several frequencies per user bit
 - Slow Hopping: several user bits per frequency
- + frequency selective fading and interference limited to short period
- + simple implementation
- + uses only small portion of spectrum at any time
- not very robust
- frequency hopping has overhead
- Example: Bluetooth

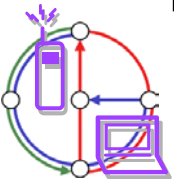

Code Division Multiple Access (CDMA)



- (Media Access Layer – could as well be in Lecture 3)
- As example for Direct Sequence Spread Spectrum (DSSS)
- Each station is assigned an m -bit code (or chip sequence)
- Typically $m = 64, 128, \dots$ (in our examples $m = 4, 8, \dots$)
- To send 1 bit, station sends chip sequence
- To send 0 bit, station sends complement of chip sequence

- Example: 1 MHz band with 100 stations
- FDM
 - each station a 10 kHz band
 - assume that you can send 1 bit/Hz: 10 kbps
- CDMA
 - each station uses the whole 1 MHz band
 - less than 100 chips per channel: more than 10 kbps

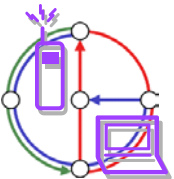

CDMA basics 1



Each station s has unique m -bit chipping code S or complement \bar{S}

Bipolar notation: binary 0 is represented by -1 (or short: $-$)

Two chips S, T are orthogonal iff $S \cdot T = 0$

$S \cdot T$ is the inner (scalar) product:
$$S \cdot T = \frac{1}{m} \sum_{i=1}^m S_i T_i$$

Note: $S \cdot S = 1, S \cdot \bar{S} = -1$

Note: $S \cdot T = 0 \Rightarrow S \cdot \bar{T} = 0$

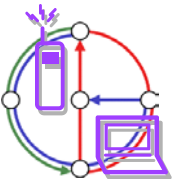

CDMA basics 2



- Assume that all stations are perfectly synchronous
- Assume that all codes are pair wise orthogonal
- Assume that if two or more stations transmit simultaneously, the bipolar signals add up linearly

- Example
- $S = (+ - + - + - + -)$
- $T = (+ + - - - + + -)$
- $U = (+ - - + - - + +)$
- Check that codes are pair wise orthogonal
- If S, T, U send simultaneously, a receiver receives $R = S+T+U = (+3, -1, -1, -1, -1, -1, +3, -1)$

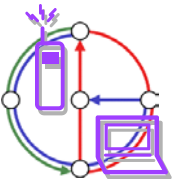

CDMA basics 3



- To decode a received signal R for sender s , one needs to calculate the inner product $R \cdot S$.
- $R \cdot S = (+3, -1, -1, -1, -1, -1, +3, -1) \cdot (+ - + - + - + -) / 8$
 $= (+3+1-1+1-1+1+3+1) / 8$
 $= 8 / 8 = 1 \dots$ by accident?
- $R \cdot S = (S+T+U) \cdot S = S \cdot S + T \cdot S + U \cdot S = 1 + 0 + 0 = 1$
- With orthogonal codes we can safely decode the original signals

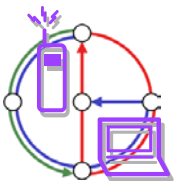

CDMA: How much noise can we tolerate?



- We now add random noise to before we receive the signal:
- $R' = R + N$, where N is an m -digit noise vector.
- Assume that chipping codes are balanced (as many “+” as “-”)
- If $N = (\alpha, \alpha, \dots, \alpha)$ for any (positive or negative) α , then the noise N will not matter when we decode the received signal.
- $R' \cdot S = (R+N) \cdot S = S \cdot S + (\text{orthogonal codes}) \cdot S + N \cdot S = 1 + 0 + 0 = 1$
- How much random (white) noise can we tolerate?
(See exercises)

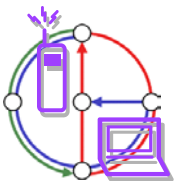

CDMA: Construction of orthogonal codes with m chips



- Note that we cannot have more than m orthogonal codes with m chips because each code can be represented by a vector in the m -dimensional space, and there are not more than m orthogonal vectors in the m -dimensional space.
- Walsh-Hadamard codes can be constructed recursively (for $m = 2^k$):

The set of codes of length 1 is $C_0 = \{(+)\}$.

For each code $(c) \in C_k$ we have two codes $(c\ c)$ and $(c\ \bar{c})$ in C_{k+1}

- Code tree:

$$C_0 = \{(+)\}$$

$$C_1 = \{(+ +), (+ -)\}$$

$$C_2 = \{(+ + + +), (+ + - -), (+ - + -), (+ - - +)\}$$

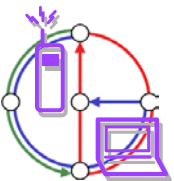

CDMA: Random codes

- We cannot have more than m orthogonal codes.
- Martin Cooper (Motorola, right) says “... with UMTS you get at most 1 Mbps ...”, the Swiss newspaper Sonntagszeitung adds “... but when you have to share a cell with 12 [16?] others, you get at most 64 kbps.”
- We said: “100 stations ... with less than 100 chips per [station]”
- Idea: Random codes are almost balanced and almost pair wise orthogonal



Coopers Kritik ist fundamentaler Natur. Das Hochgeschwindigkeits-Netz sei schlichtweg nicht so leistungsfähig, wie es die Industrie behauptet. Im besten Fall könnten die Nutzer auf eine Übertragungsgeschwindigkeit von 1 Megabit pro Sekunde (Mbps) hoffen. Das ist zwar mehr als 15-mal so schnell wie eine ISDN-Leitung, aber nur die Hälfte der ursprünglich von den Ausrüstern versprochenen Leistung.

Das Ziel ist eine superschnelle mobile Datenübermittlung

Aber auch das eine Megabit ist bisher nur unter Laborbedingungen machbar. «Die Crux liegt im Detail», sagt Handy-Erfinder Cooper, «Alle Nutzer innerhalb einer Funkzelle müssen sich die Bandbreite teilen.» Befinden sich beispielsweise zwölf Personen in einer solchen Zelle (das ist der Sendebereich einer Funkantenne), können sie realistischerweise nur noch 64 Kilobits pro Sekunde erwarten. Das schaffen heute sogar ganz normale Analogmodems für Einwahlverbindungen im Festnetz. «Die Träumerei von Hollywood-Filmen auf dem Handy ist vergeblich», sagt Cooper.

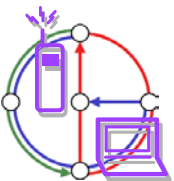

CDMA: Random codes 2



- With k other stations, and m chips
- $m \cdot R \cdot S = m \cdot S \cdot S + m \cdot (k \text{ random codes}) \cdot S = \pm m + X$, where X is the sum of mk random variables that are either $+1$ or -1 .
- Since the random variables are independent, the expected value of X is 0 . And better: The probability that X is “far from 0 ” is “small.”
- Therefore we may decode the signal as follows:
 $R \cdot S > \epsilon \Rightarrow$ decode 1 ; $R \cdot S < -\epsilon \Rightarrow$ decode 0 . What if $-\epsilon \leq R \cdot S \leq \epsilon$??

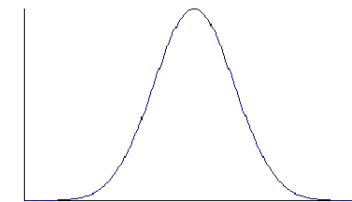

- Experimental evaluation (right): For $k = m = 128$ decoding is correct more than 80%. But more importantly: Even if $k > m$ ($k=1..500$), the system does not deteriorate quickly.

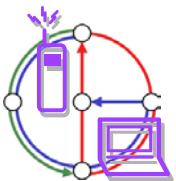
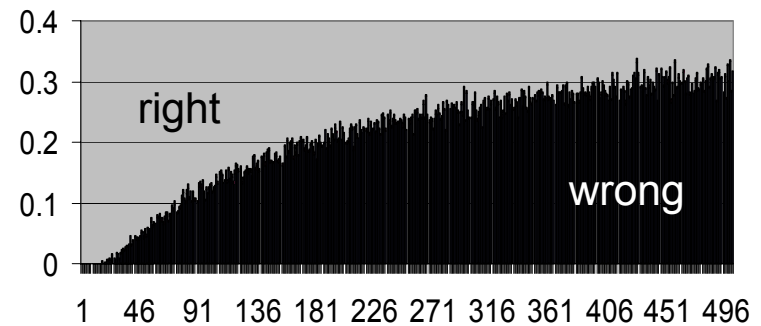

CDMA: Problems



Some of our assumptions were not accurate:

- A) It is not possible to synchronize chips perfectly. What can be done is that the sender first transmits a long enough known chip sequence on which the receiver can lock onto.

- B) Not all stations are received with the same power level. CDMA is typically used for systems with fixed base stations. Then mobile stations can send with the reciprocal power they receive from the base station. (Alternatively: First decode the best station, and then subtract its signal to decode the second best station?)

- C) We still didn't discuss how to transmit bits with electromagnetic waves.

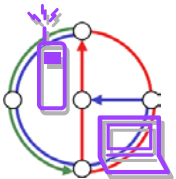

CDMA: Summary



- + all terminals can use the same frequency, no planning needed
- + reduces frequency selective fading and interference
- + base stations can use the same frequency range
- + several base stations can detect and recover the signal
- + soft handover between base stations
- + forward error correction and encryption can be easily integrated
- precise power control necessary
- higher complexity of receiver and sender

Examples: “Third generation” mobile phones, UMTS, IMT-2000.

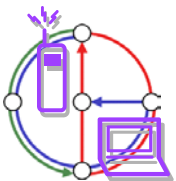

Modulation and demodulation

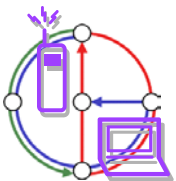
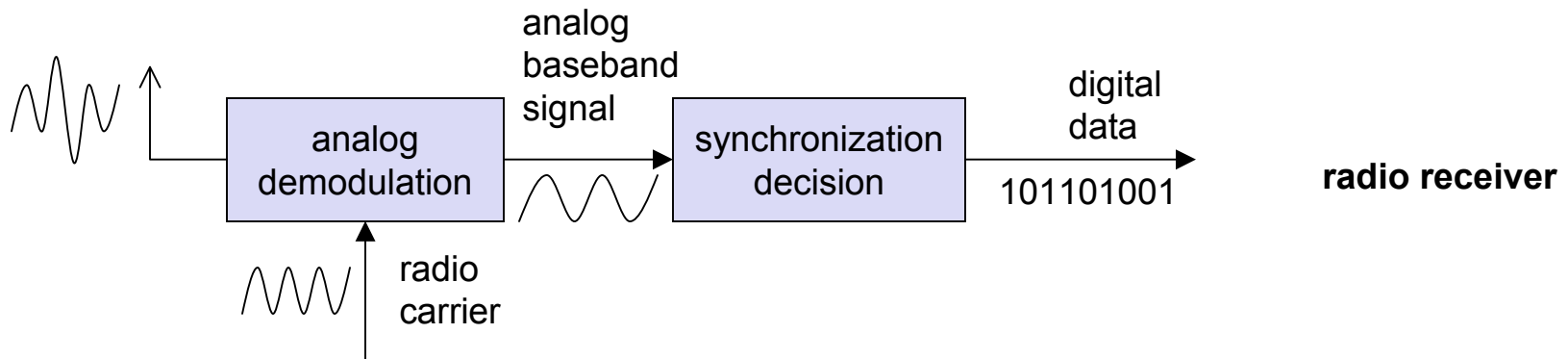
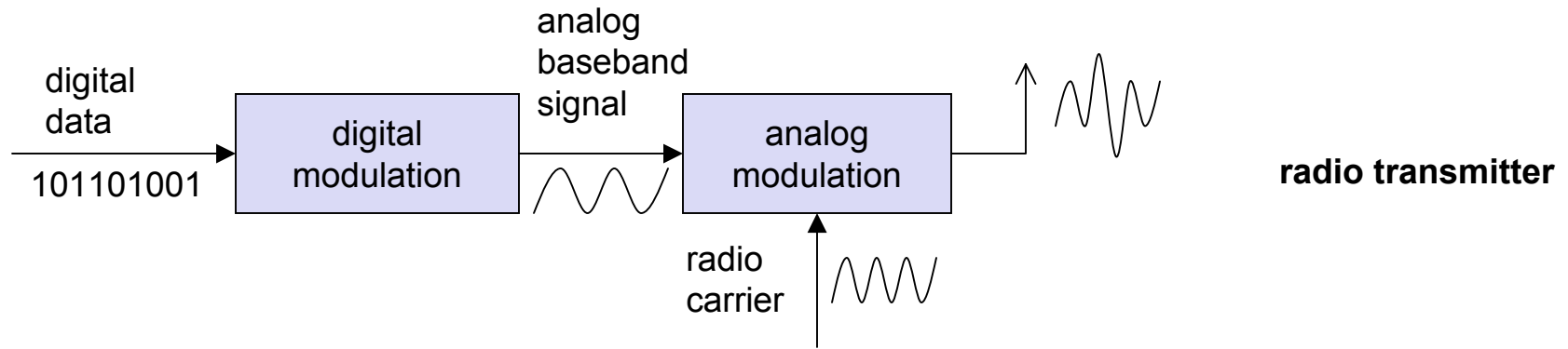

Digital modulation



- Modulation of digital signals known as Shift Keying
- Amplitude Shift Keying (ASK):
 - very simple
 - low bandwidth requirements
 - very susceptible to interference
- Frequency Shift Keying (FSK):
 - needs larger bandwidth
- Phase Shift Keying (PSK):
 - more complex
 - robust against interference

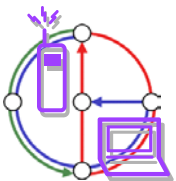
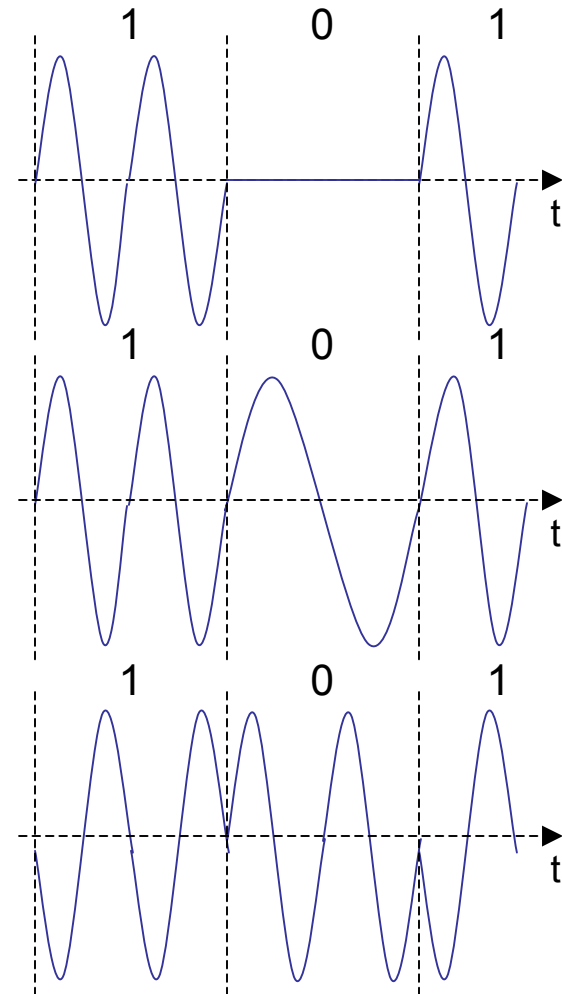

Different representations of signals



- For many modulation schemes not all parameters matter.

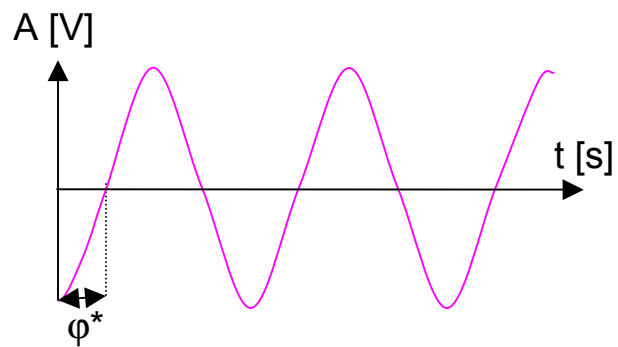

amplitude domain



frequency spectrum

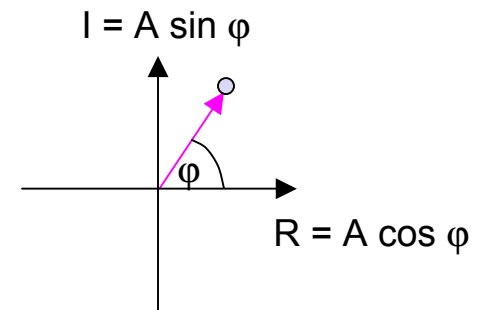

phase state diagram

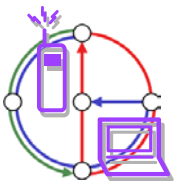

Advanced Frequency Shift Keying



- MSK (Minimum Shift Keying)
- bandwidth needed for FSK depends on the distance between the carrier frequencies
- Avoid sudden phase shifts by choosing the frequencies such that (minimum) frequency gap $\delta f = 1/4T$ (where T is a bit time)
- During T the phase of the signal changes continuously to $\pm \pi$
- Example GSM: GMSK (Gaussian MSK)

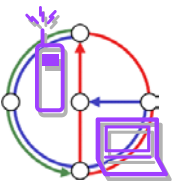

Advanced Phase Shift Keying



- BPSK (Binary Phase Shift Keying):
 - bit value 0: sine wave
 - bit value 1: inverted sine wave
 - Robust, low spectral efficiency
 - Example: satellite systems

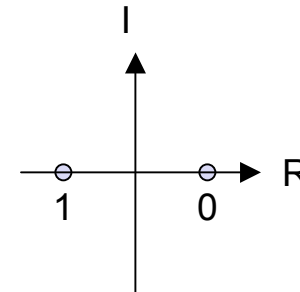

- QPSK (Quadrature Phase Shift Keying):
 - 2 bits coded as one symbol
 - symbol determines shift of sine wave
 - needs less bandwidth compared to BPSK
 - more complex

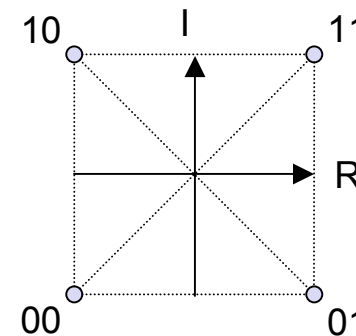

- Dxxxx (Differential xxxx)

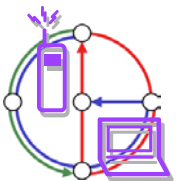

Modulation Combinations



- Quadrature Amplitude Modulation (QAM)
- combines amplitude and phase modulation
- it is possible to code n bits using one symbol
- 2^n discrete levels, n=2 identical to QPSK
- bit error rate increases with n, but less errors compared to comparable PSK schemes

- Example: 16-QAM (4 bits = 1 symbol)
- Symbols 0011 and 0001 have the same phase, but different amplitude. 0000 and 1000 have different phase, but same amplitude.
- Used in 9600 bit/s modems

