

# COMPUTER NETWORKS

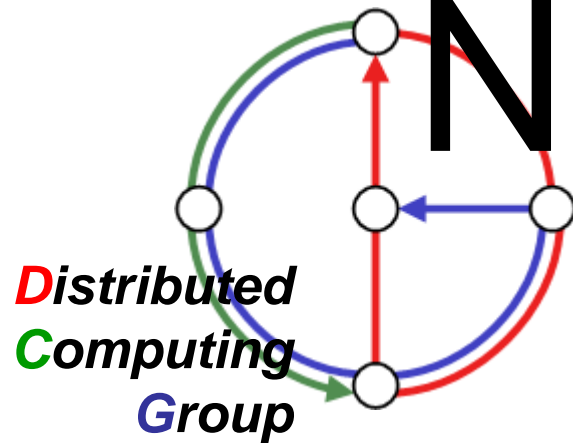

Roger Wattenhofer  
Summer 2005

# Chapter 1

# INTRODUCTION

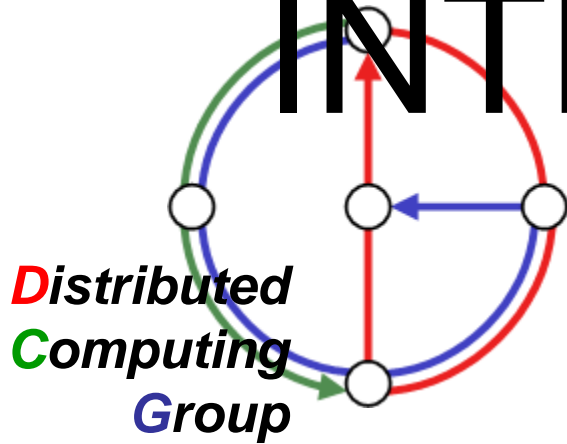

Computer Networks

Summer 2005

# Overview



- What's the Internet?
- What's a protocol?
- Network edge vs. core
- Access net, physical media
- Performance: loss, delay
- Protocol layers, service models
- Backbones, NAPs, ISPs
- History & Future
  
- Goal: get context, overview, “feeling” of networking, postpone details.

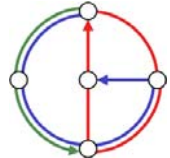

# What's the Internet: "nuts and bolts" view



- Millions of connected computing devices: Hosts, End-Systems
  - PC's, workstations, servers
  - PDA's, phones, toastersrunning network applications
- Communication links
  - fiber, copper, radio
- Routers
  - forward packets (chunks) of data through network



router



server



workstation



mobile

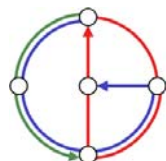
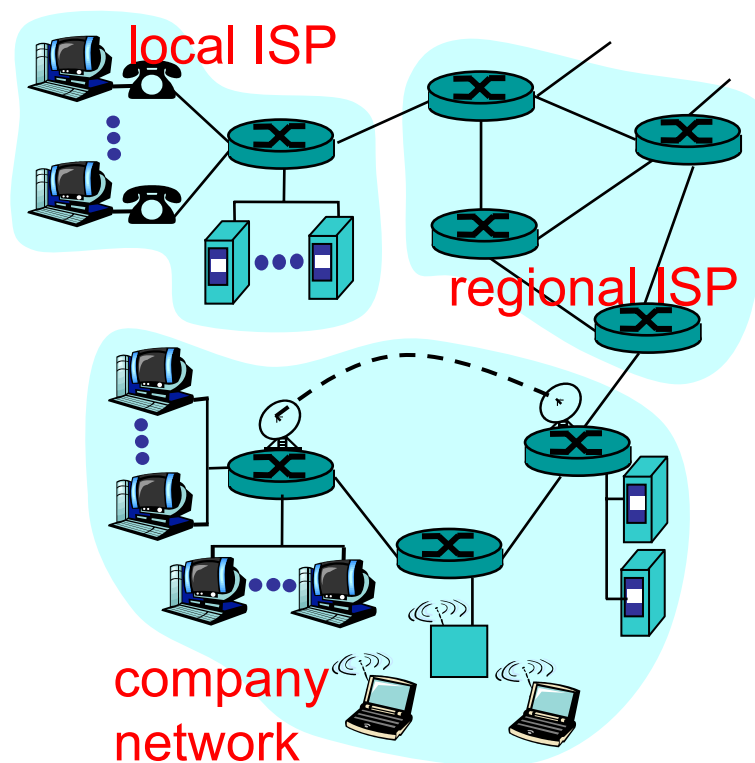

# “Cool” Internet appliances



IP picture frame  
[[www.ceiva.com](http://www.ceiva.com)]



Web-enabled toaster and  
weather forecaster



World's smallest web server  
[[www-ccs.cs.umass.edu/~shri/iPic.html](http://www-ccs.cs.umass.edu/~shri/iPic.html)]

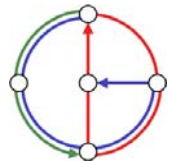

# What's the Internet: "nuts and bolts" view



- protocols: control sending, receiving of messages
  - TCP, IP, HTTP, FTP, PPP
- Internet: "network of networks"
  - loosely hierarchical
  - public Internet versus private Intranet
- Internet standards
  - RFC: Request for comments
  - IETF: Internet Engineering Task Force



router



workstation



server



mobile

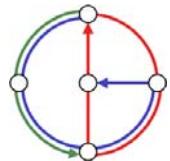
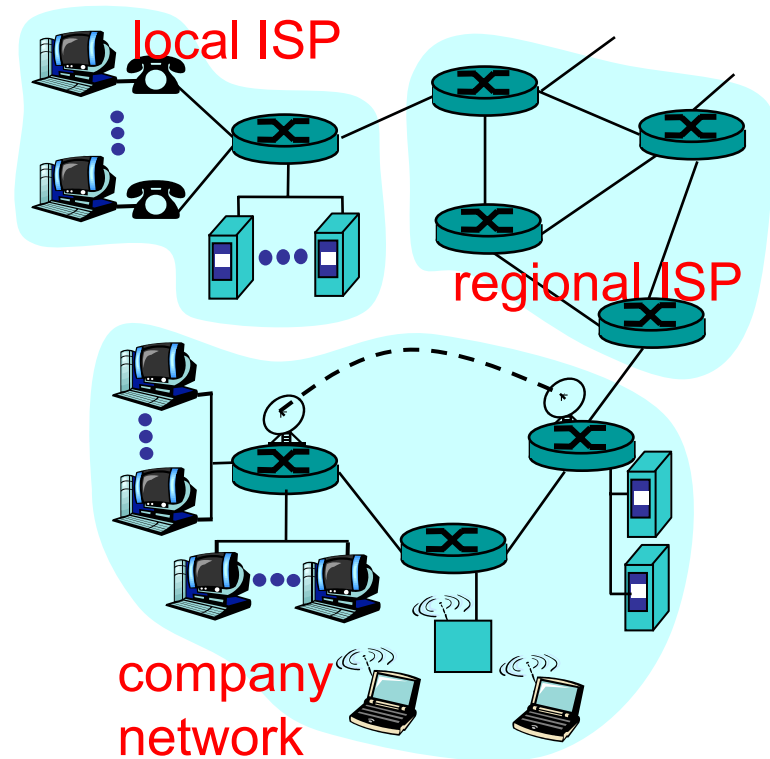

# What's the Internet: a service view



- communication infrastructure enables distributed applications
  - WWW, email, games, e-commerce, databases, voting, file (MP3) sharing
- communication services provided
  - connectionless
  - connection-oriented

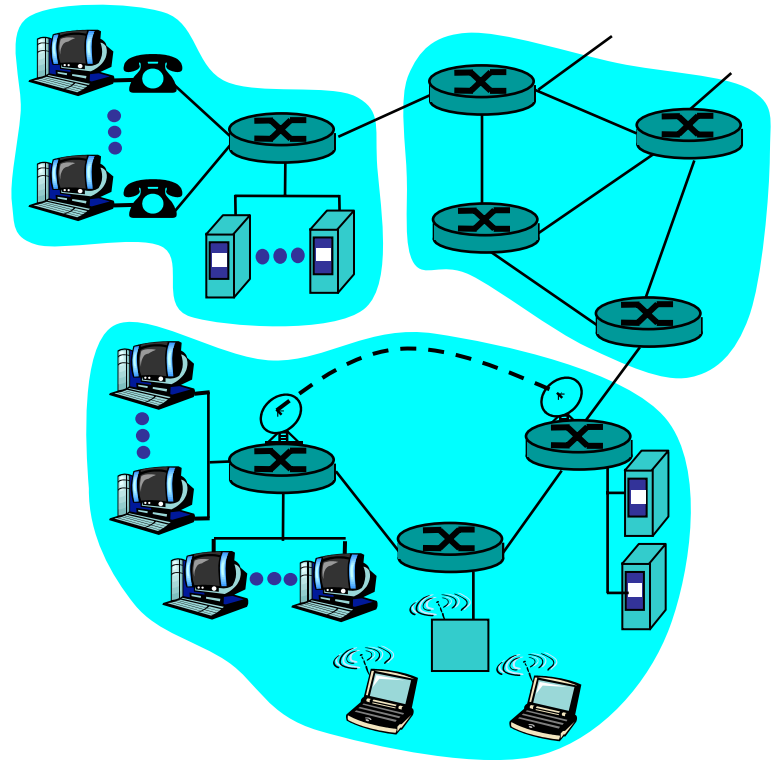

- cyberspace [Gibson]:  
“a consensual hallucination experienced daily by billions of operators, in every nation, ....”

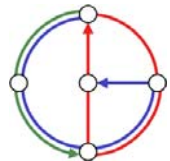

# What's a protocol?



## Human protocols

- “what’s the time?”
- “I have a question”
- introductions

... specific msgs sent

... specific actions taken  
when msgs received, or  
other events

## Network protocols

- machines rather than humans
- all communication activity in Internet governed by protocols

*protocols define format, order of msgs sent and received among network entities, and actions taken on msg transmission, receipt*

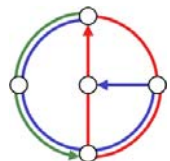



# What's a protocol?



a human protocol

and

a computer network protocol

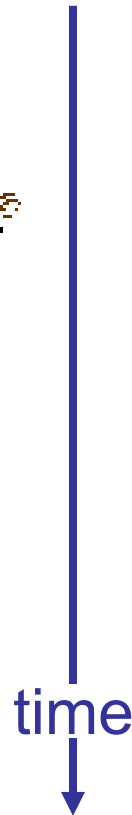
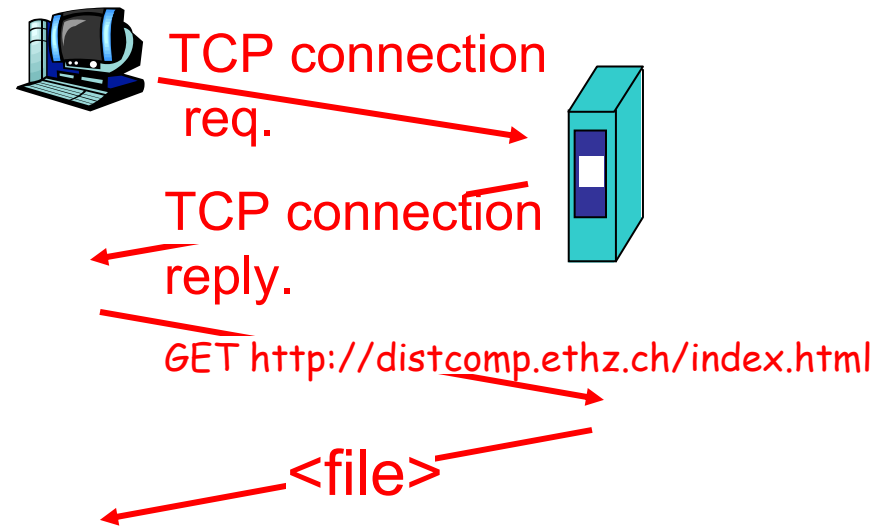
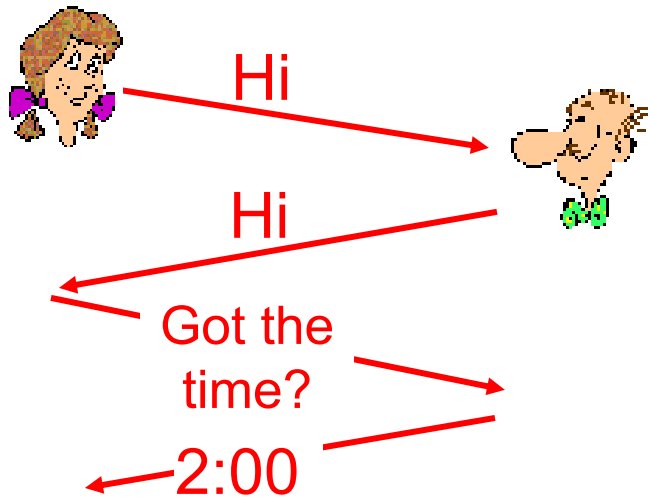

Do you know other human protocols?

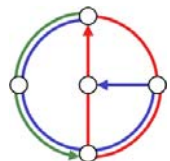

# A closer look at network structure



- network edge
  - hosts and applications
- network core
  - routers
  - network of networks
- access networks, physical media
  - communication links

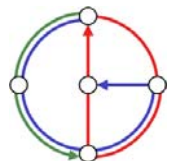
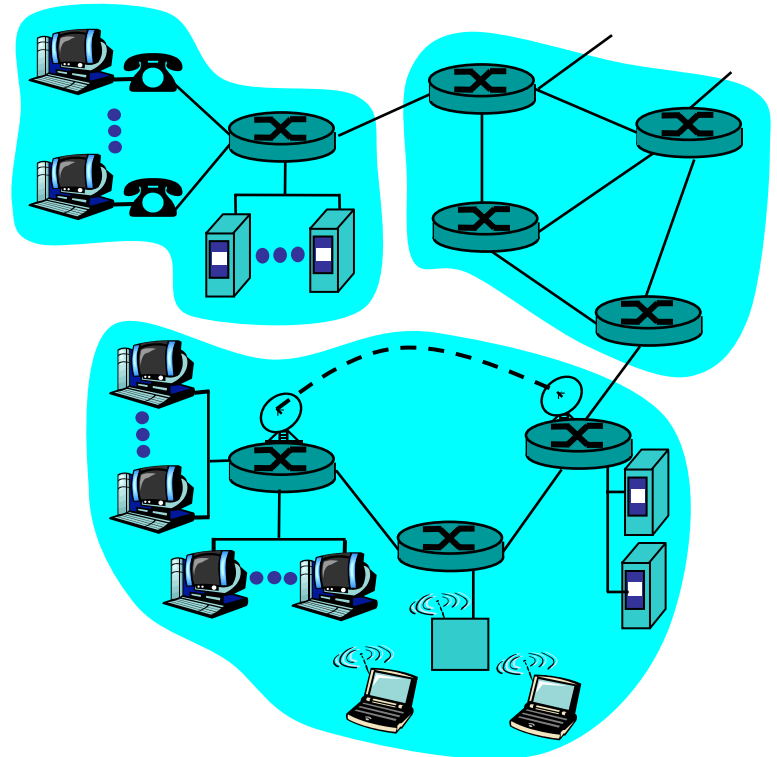

# The network edge



- end systems (hosts)
  - run application programs
  - e.g. WWW, email
  - at “edge of network”
- client/server model
  - client host requests, receives service from server
  - e.g. WWW client (browser) /server; email client/server
- peer-to-peer model
  - host interaction symmetric
  - e.g. Kazaa, Emule

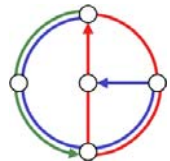
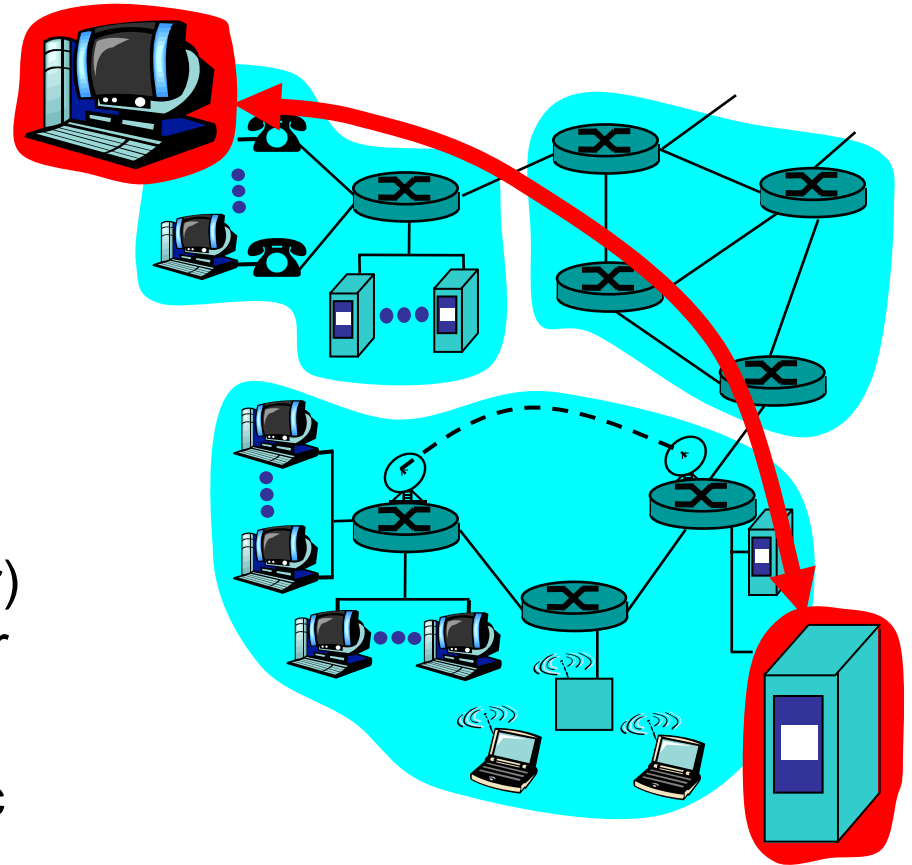

# Network edge: connection-oriented service



Goal: data transfer between end systems

- handshaking: setup (prepare for) data transfer ahead of time
  - “Hello, hello back” human protocol
  - set up “state” in two communicating hosts
- TCP
  - Transmission Control Protocol
  - connection-oriented service of the Internet

TCP [RFC 793]

- reliable, in-order byte-stream data transfer
  - loss: acknowledgements and retransmissions
- flow control
  - sender won’t overwhelm receiver
- congestion control
  - senders “slow down sending rate” when network congested

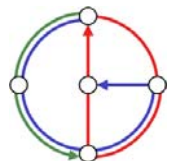

# Network edge: connectionless service



*Goal:* data transfer between end systems

- same as before!
- UDP - User Datagram Protocol [RFC 768]
  - Internet's connectionless service
  - unreliable data transfer
  - no flow control
  - no congestion control

App's using TCP

- HTTP (WWW)
- FTP (file transfer)
- Telnet (remote login)
- SMTP (email)

App's using UDP

- streaming media
- teleconferencing
- Internet telephony

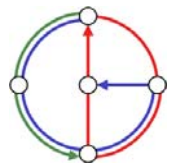

# The network core



- “graph” of interconnected routers
- the fundamental question: how is data transferred through net?
- Circuit switching
  - dedicated circuit per call
  - telephone network
- Packet switching
  - data sent through network in discrete “chunks”

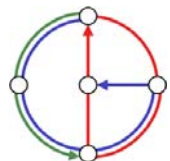
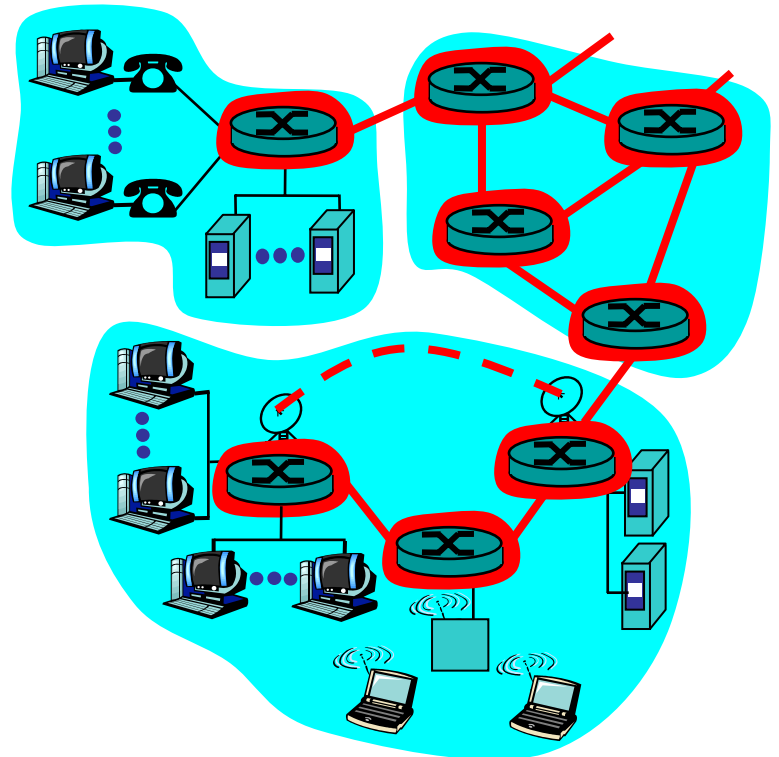

# Circuit Switching

- End-end resources reserved for “call”
- Divide link bandwidth into “pieces”
  - Frequency division
  - Time division
- dedicated resources  
no sharing; “piece” is idle if not used by user
- circuit-like (guaranteed) performance
- call setup required

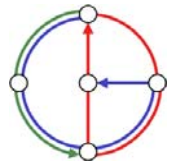
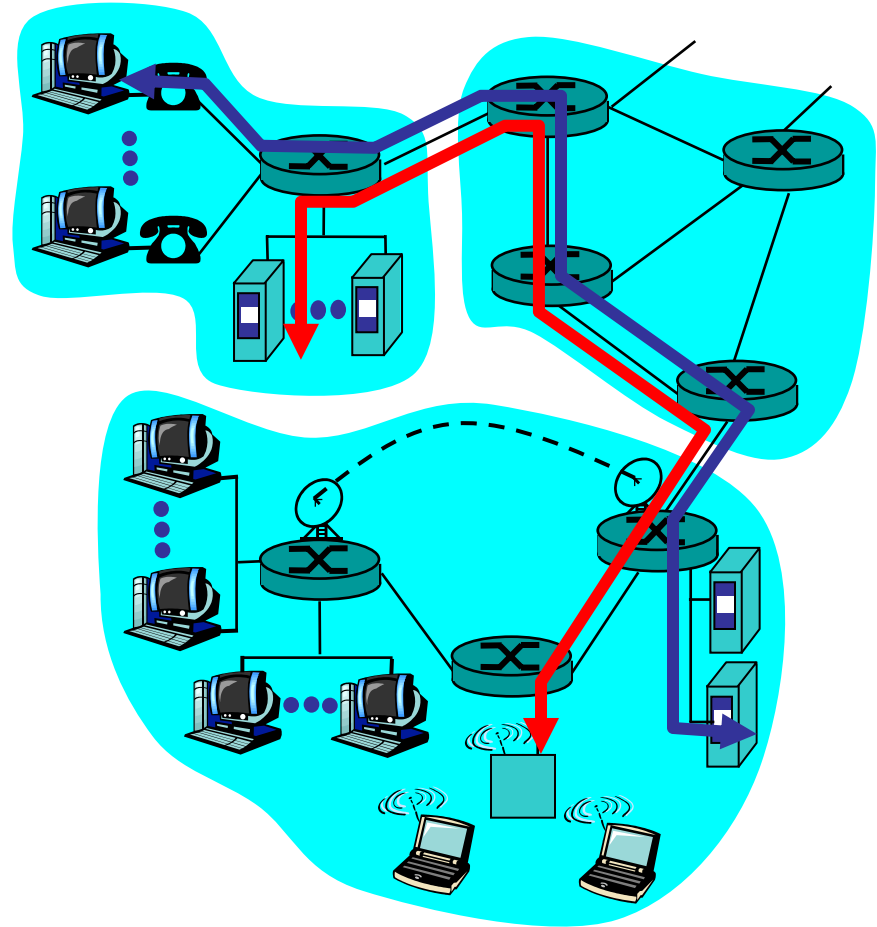

# Frequency Division and Time Division Multiple Access



Example:

4 users



FDMA

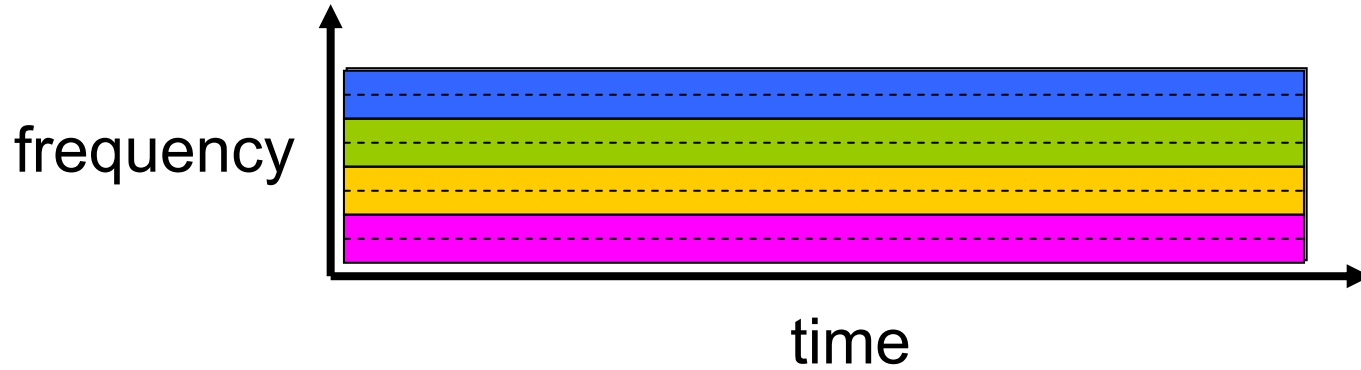

TDMA

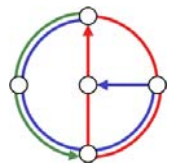
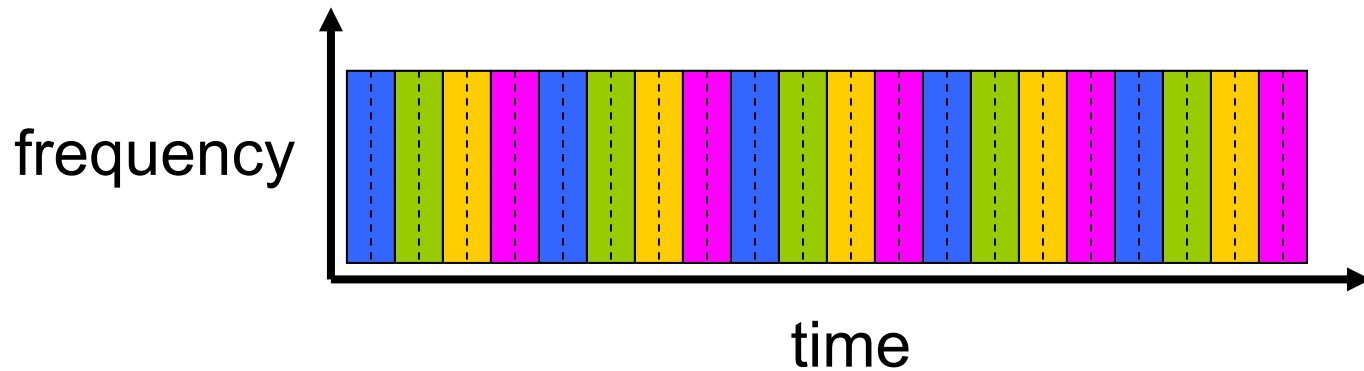



# Packet Switching



- each end-end data stream divided into packets
- packets share network resources
- each packet uses full link bandwidth
- resources used as needed
- resource contention
  - aggregate resource demand can exceed amount available
- congestion
  - packets queue
  - wait for link use
- store-and-forward
  - packets move one hop at a time
  - router receives whole packet before sending the first bit over the next link

Bandwidth division into “pieces”

Dedicated allocation  
Resource reservation

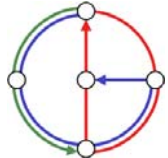
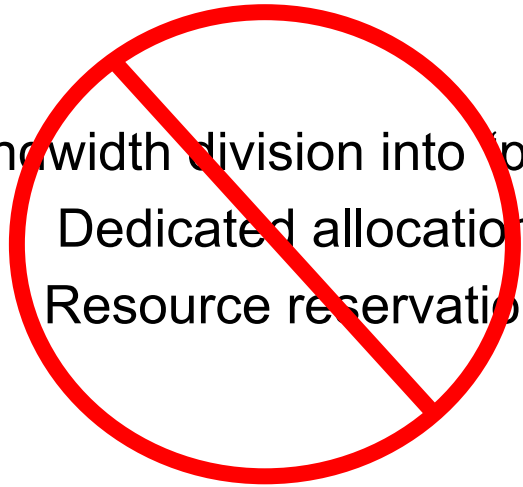

# Packet Switching

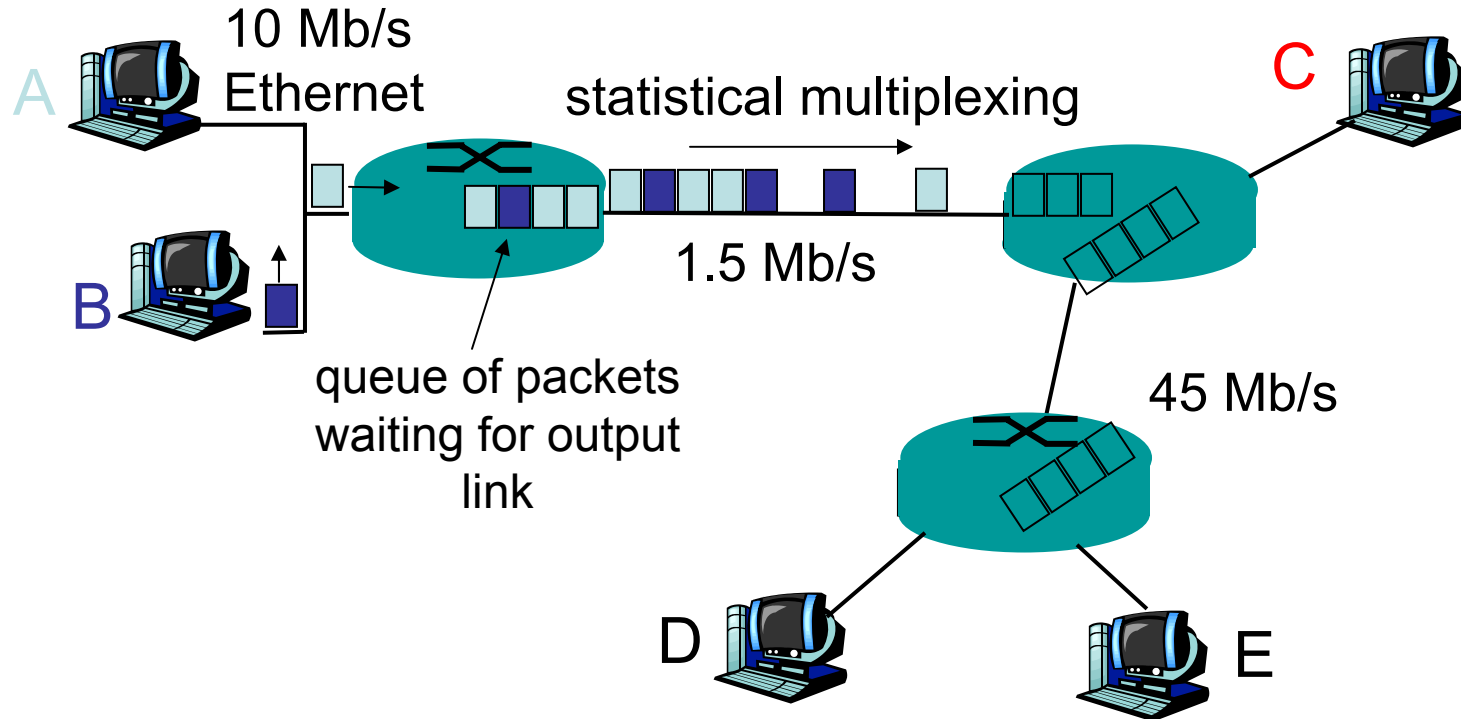

- Real-world example for packet switching: Cafeteria (ETH Mensa)

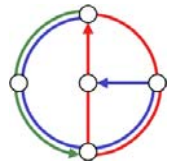

# Circuit switching vs. Packet switching



- 1 Mbit link
- each user
  - 100Kbps when “active”
  - active 10% of time

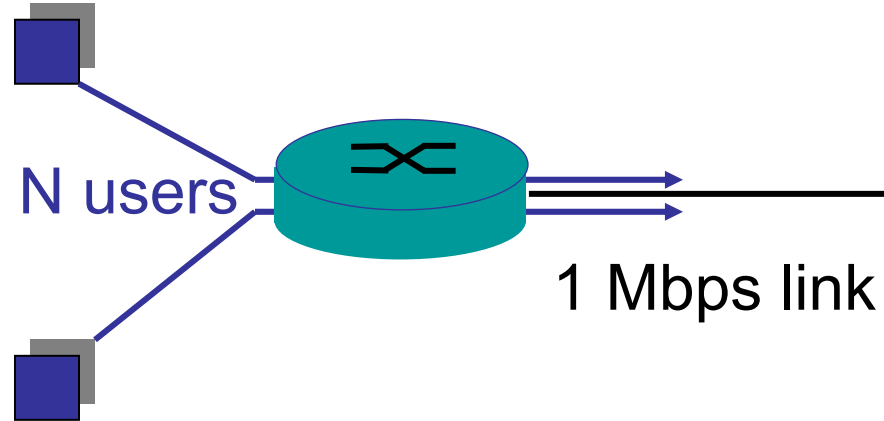

- circuit-switching
  - 10 users
- packet switching:
  - with 50 users,  $\text{Pr}[\text{more than 10 users active}] < 1\%$
  - with 100 users,  $\text{Pr}[\text{more than 10 users active}] \approx 42\%$
- Packet switching allows more users... Really?

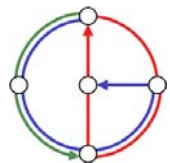

# Packet Switching

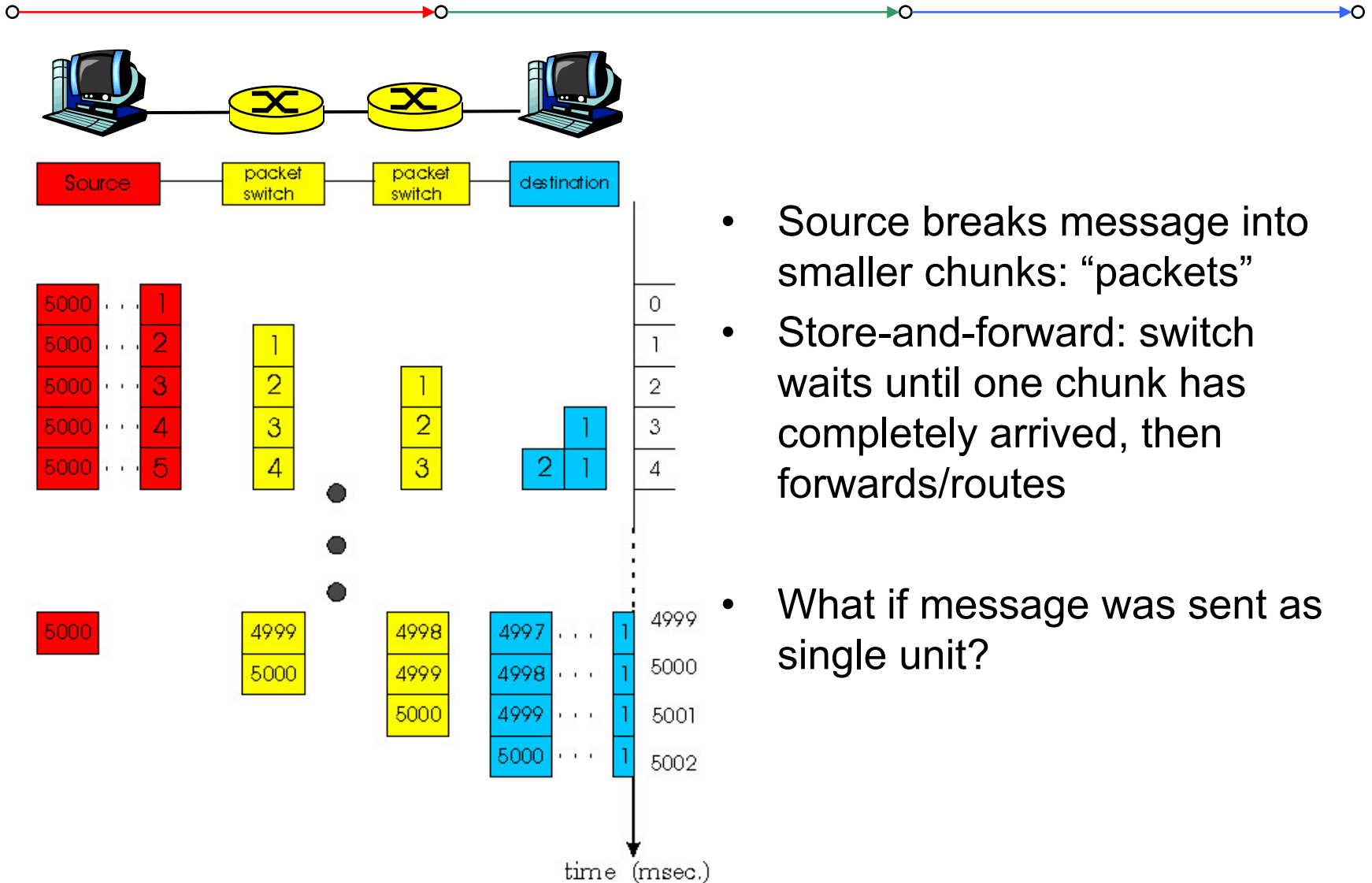

- Source breaks message into smaller chunks: “packets”
- Store-and-forward: switch waits until one chunk has completely arrived, then forwards/routes
- What if message was sent as single unit?

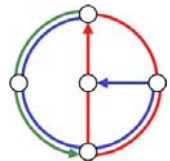

# Circuit switching vs. Packet switching



- Is packet switching a “slam dunk winner“?
- Great for bursty data
  - resource sharing
  - no call setup
- But: Excessive congestion: packet delay and loss
  - protocols needed for reliable data transfer
  - header overhead
  - congestion control
- How to provide circuit-like behavior?
  - bandwidth guarantees needed for audio/video apps
  - still an unsolved problem

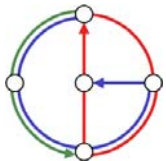

# Packet-switched networks: Routing



- Goal: move packets among routers from source to destination
- We later study several path selection algorithms
- datagram network
  - destination address determines next hop
  - routes may change during session
  - analogy: driving, asking directions
- virtual circuit network
  - each packet carries tag (virtual circuit ID)
  - tag determines next hop
  - fixed path determined at call setup time, remains fixed
  - routers maintain per-call state

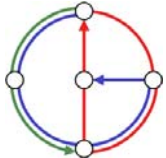

# Delay in packet-switched networks



- packets experience delay on end-to-end path
- four sources of delay at each hop
  - Nodal processing
    - check bit errors
    - determine output link
  - Queuing
    - time waiting at output link for transmission
    - depends on congestion level of router

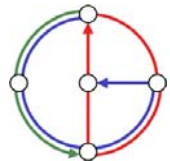
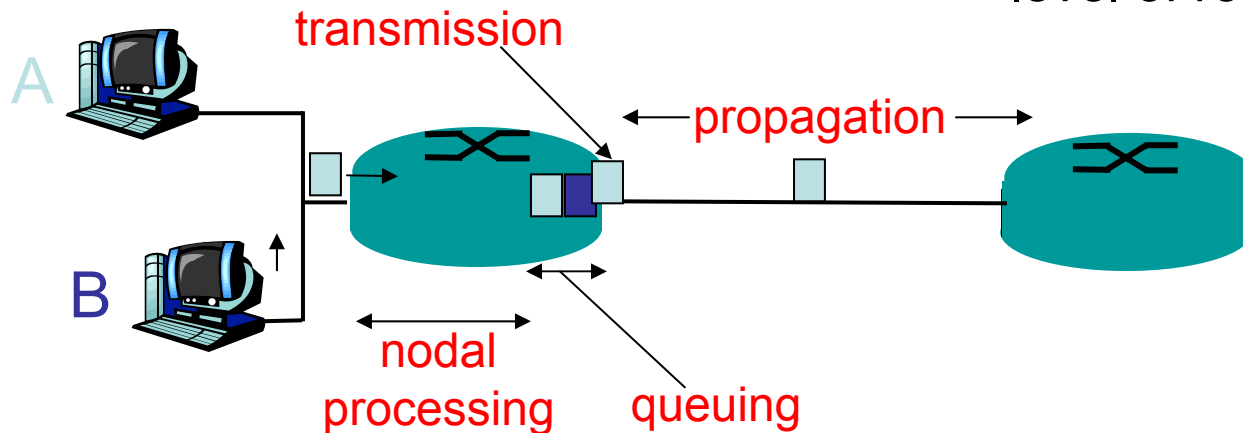

# Delay in packet-switched networks



- Transmission delay:
  - $R$  = link bandwidth (bps)
  - $L$  = packet length (bits)
  - time to send bits into link =  $L/R$
- Propagation delay:
  - $d$  = length of physical link
  - $s$  = propagation speed in medium ( $\sim 2 \times 10^8$  m/sec)
  - propagation delay =  $d/s$

Note:  $s$  and  $R$  are different quantities!

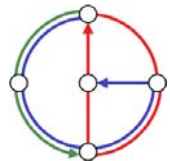
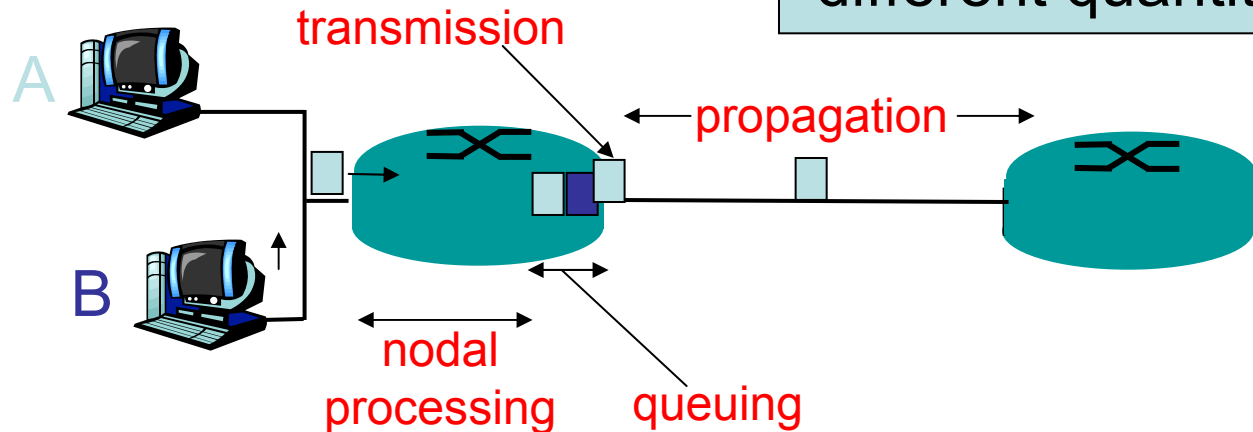



# Queuing delay



- $R$ =link bandwidth (bps)
- $L$ =packet length (bits)
- $a$ =average packet arrival rate (packets per second)

- Arrival rate  $\lambda = La$  (bps)
- Service rate  $\mu = R$  (bps)
- Traffic intensity  $\rho = \lambda / \mu$

- $\rho$  small: average queuing delay small
- $\rho \rightarrow 1$ : delays become large
- $\rho \geq 1$ : more “work” arriving than can be serviced, average delay grows infinitely!

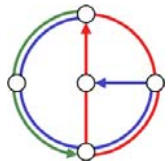
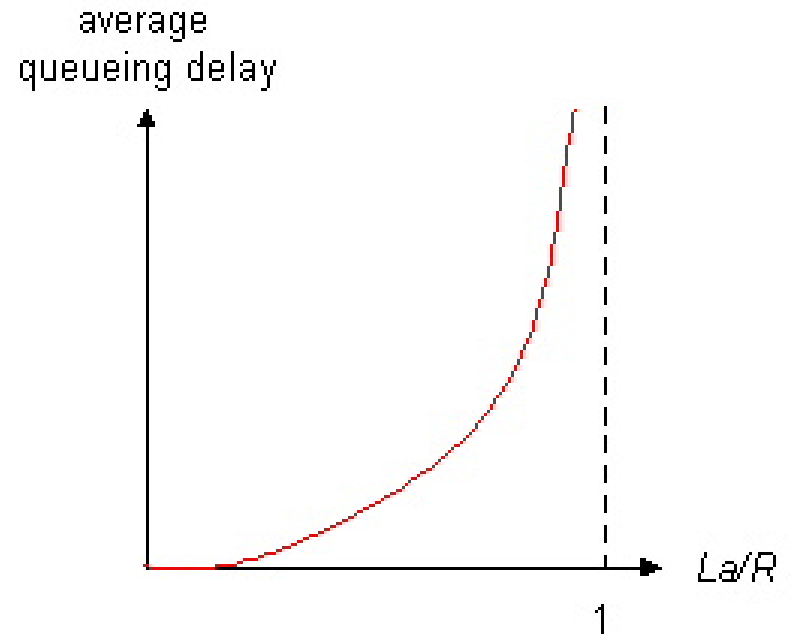

# “Real” Internet delays and routes: traceroute



Tracing route from photek.ethz.ch [129.132.13.122] to google.com [216.239.35.100]:

1	<10 ms	<10 ms	<10 ms	rou-ifw-1-inf-vs.ethz.ch [129.132.13.65]
2	<10 ms	<10 ms	<10 ms	rou-gw-switch-1-mega-transit-2.ethz.ch [129.132.99.213]
3	<10 ms	<10 ms	<10 ms	swiez2.ethz.ch [192.33.92.11]
4	<10 ms	<10 ms	<10 ms	swilX1-G2-3.switch.ch [130.59.36.250]
5	<10 ms	<10 ms	<10 ms	zch-b1-geth4-1.telia.net [213.248.79.189]
6	<10 ms	10 ms	<10 ms	ffm-b1-pos5-3.telia.net [213.248.77.133]
7	10 ms	20 ms	20 ms	213.248.68.90
8	10 ms	20 ms	20 ms	de-cix.fra.above.net [80.81.192.226]
9	<10 ms	10 ms	<10 ms	so-0-1-0.cr1.fra1.de.mfnx.net [216.200.116.213]
10	10 ms	20 ms	10 ms	pos9-0.cr1.cdg2.fr.mfnx.net [64.125.31.161]
11	40 ms	41 ms	50 ms	so-5-0-0.cr1.lhr3.uk.mfnx.net [64.125.31.154]
12	100 ms	100 ms	100 ms	so-7-0-0.cr1.dca2.us.mfnx.net [64.125.31.186]
13	170 ms	180 ms	170 ms	so-3-0-0.mpr3.sjc2.us.mfnx.net [208.184.233.133]
14	170 ms	180 ms	180 ms	so-0-0-0.mpr4.sjc2.us.mfnx.net [64.125.30.2]
15	170 ms	180 ms	180 ms	so-1-0-0.cr2.sjc3.us.mfnx.net [208.184.233.50]
16	170 ms	180 ms	170 ms	pos1-0.er2a.sjc3.us.mfnx.net [208.185.175.198]
17	160 ms	150 ms	160 ms	sjni1-2-3.net.google.com [216.239.48.238]
18	170 ms	170 ms	160 ms	sjbi1-1-1.net.google.com [216.239.47.162]
19	151 ms	150 ms	160 ms	www.google.com [216.239.35.100]

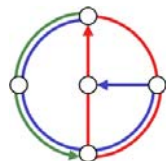

# Networking Taxonomy

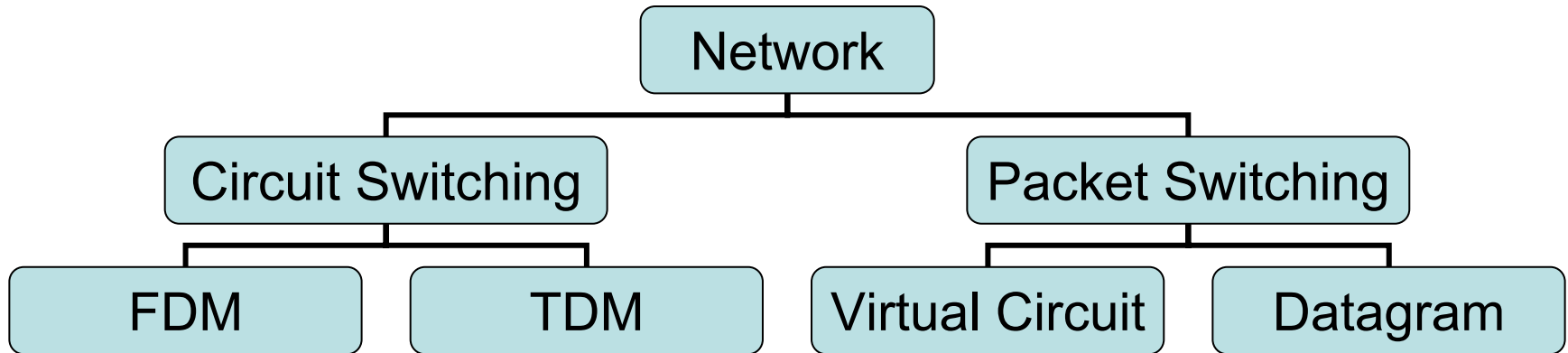

- We concentrate on right-hand path (predominant in Internet)

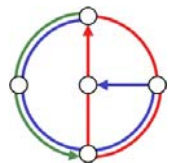

# Access networks and physical media



Q: How to connect end systems to edge router?

- residential access nets
- institutional access networks (school, company)
- mobile access networks

Keep in mind

- bandwidth (bits per second) of access network?
- shared or dedicated?

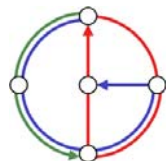
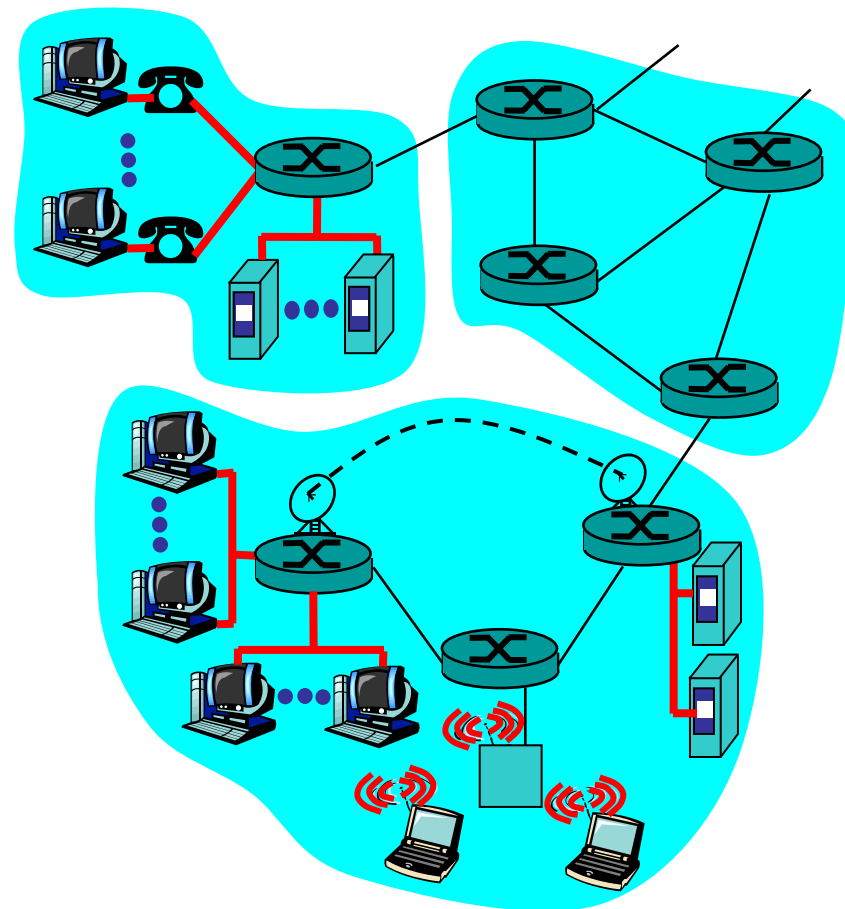

# Residential access: point to point access



- Dialup via modem
  - up to 56Kbps direct access to router (conceptually)
- ISDN
  - integrated services digital network
  - 128Kbps all-digital connect to router
- ADSL
  - asymmetric digital subscriber line
  - up to 1 Mbps home-to-router
  - up to 8 Mbps router-to-home
  - ADSL deployment: happening

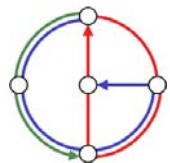
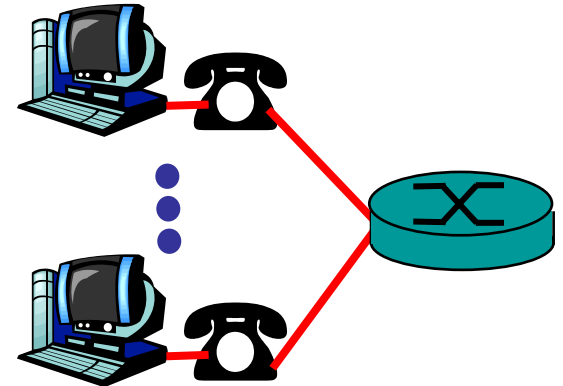

# Residential access: cable modems

- Other forms of cable modems
  - Power line: e.g. Ascom Powerline
  - TV cable modem: e.g. CableCom, Glattnet
  - Satellite with feedback on phone line
  - Wireless local loop

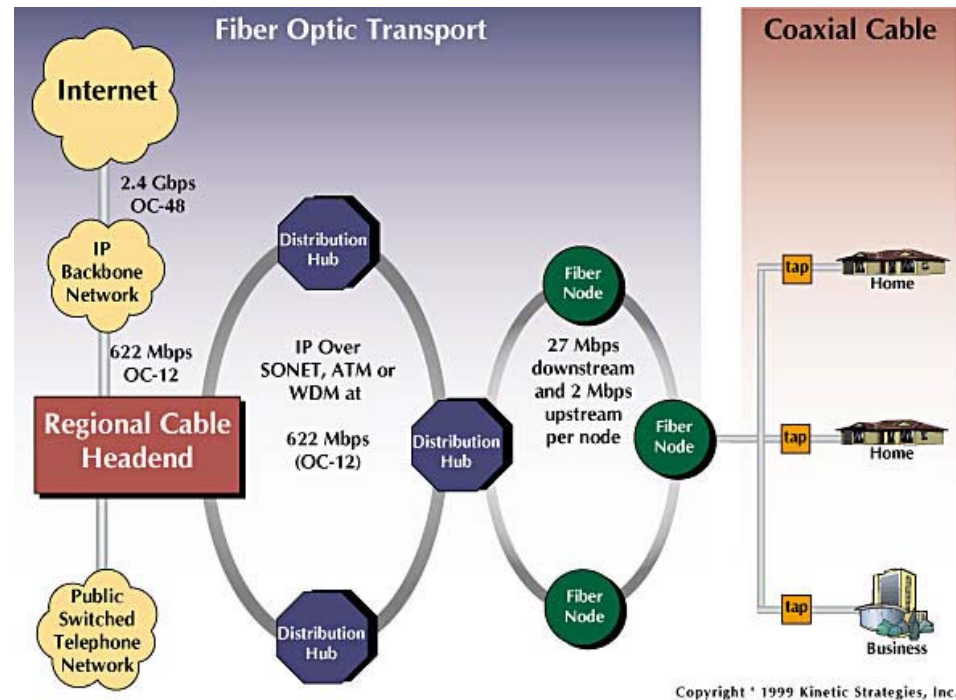

[<http://www.cabledatcomnews.com/cm/cic/diagram.html>]

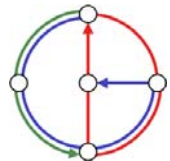

# Institutional access: local area networks

- company/university local area network (LAN) connects end system to edge router
- Example: Ethernet
  - shared or dedicated cable connects end systems and router
  - 10 Mbps, 100Mbps, Gigabit Ethernet
- deployment: institutions, home LANs happening now

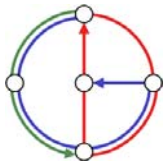
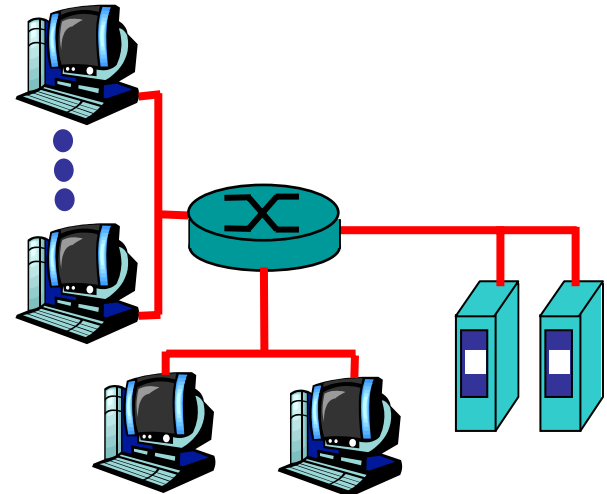

# Wireless access networks



- shared *wireless* access network connects end system to router
- wireless LANs
  - radio spectrum replaces wire
  - 802.11b with 11 Mbps
  - 802.11a with up to 54 Mbps
- wider-area wireless access
  - GSM: wireless access to ISP router via cellular network

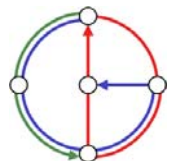
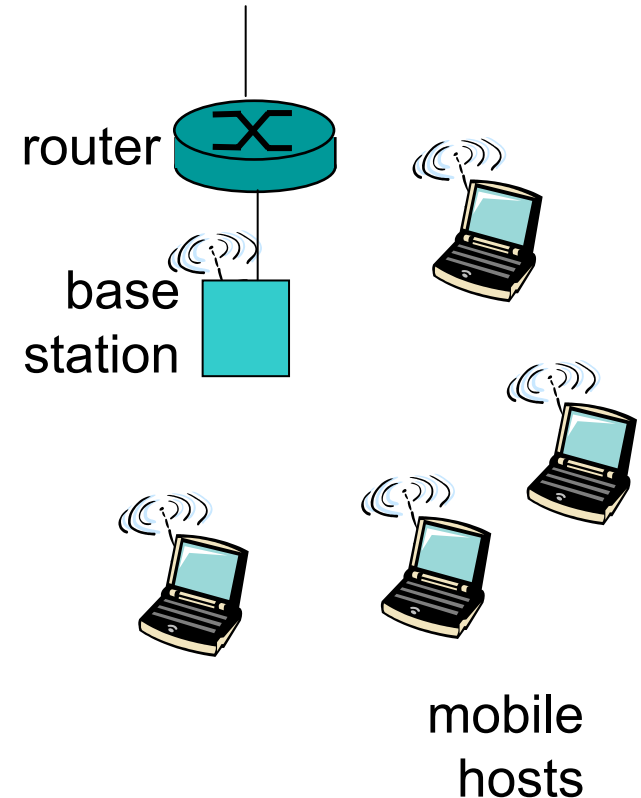



# Home networks



## Typical home network components

- ADSL or cable modem
- router/firewall
- Ethernet
- wireless access point

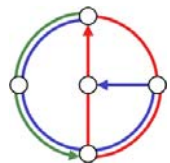
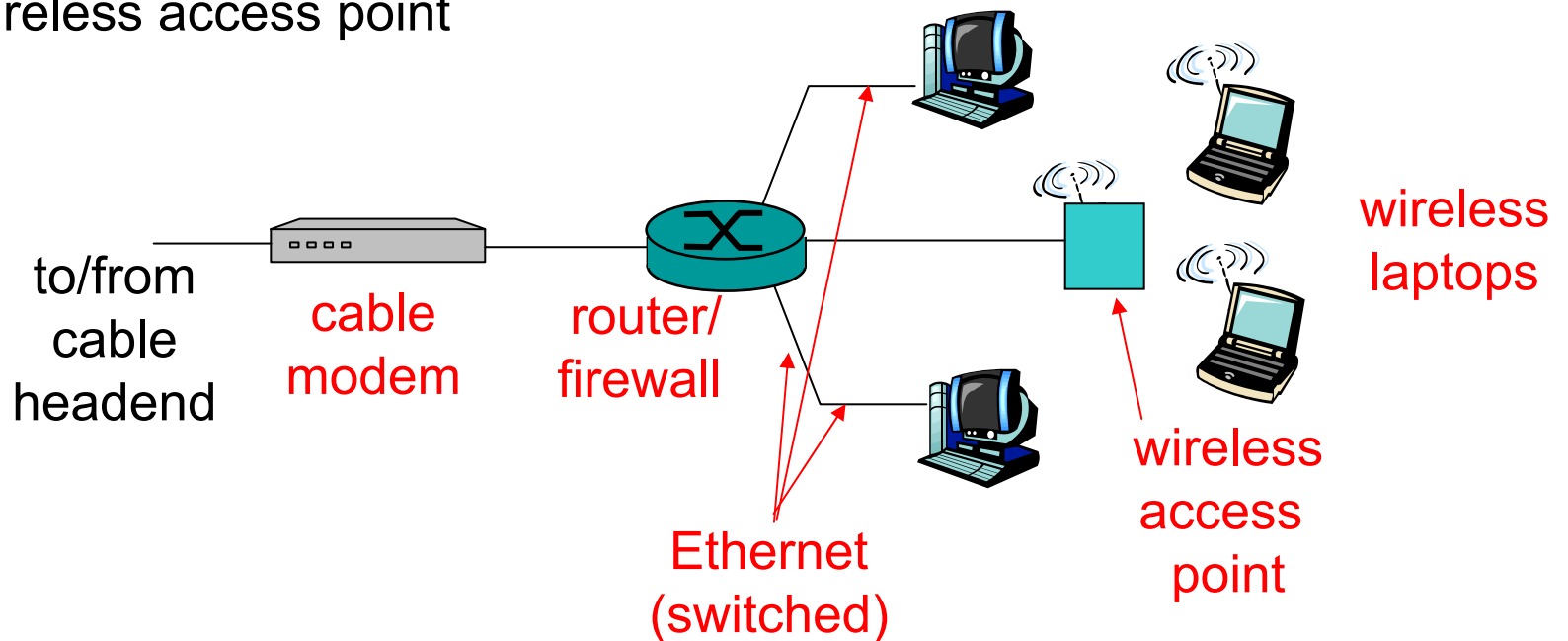

# Physical Media



- physical link
  - transmitted data bit propagates across link
- guided media
  - signals propagate in solid media: copper, fiber
- unguided media
  - signals propagate freely, e.g. radio
- Twisted Pair TP (UTP, STP)
  - two insulated copper wires
    - traditional phone wires
    - 10 Mbps Ethernet
  - Category 3
    - 100Mbps Ethernet
  - Category 5
    - 1Gbps Ethernet
  - Category 6
    - 1Gbps Ethernet

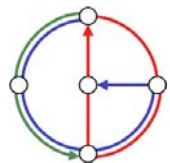

# Physical Media: coax, fiber



- Coaxial cable:
  - wire (signal carrier) within a wire (shield)
  - variant baseband (“50Ω”)
    - single channel on cable
  - variant broadband (“75Ω”)
    - multiple channels on cable
  - bidirectional
  - 10Mbps Ethernet
- Fiber optic cable:
  - glass fiber carrying light pulses
  - high-speed operation: 100Mbps Ethernet
  - high-speed point-to-point transmission (>10 Gbps)
  - low error rate

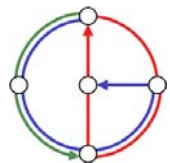
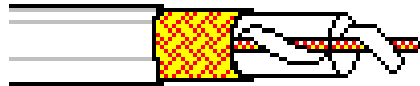

# Physical media: Radio



- signal carried in electromagnetic spectrum
- no physical “wire”
- bidirectional
- propagation environment effects:
  - reflection
  - obstruction by objects
  - interference
- Radio link types:
  - microwave
    - e.g. up to 45 Mbps
  - Wireless LAN (802.11)
    - 2Mbps, 11Mbps, 54Mbps
  - wide-area (e.g. cellular)
    - GSM, 10’s Kbps
    - UMTS, Mbps
  - satellite
    - up to 50Mbps channel (or multiple smaller channels)
    - GEO: 270 msec end-end delay
    - geosynchronous vs. LEO’s

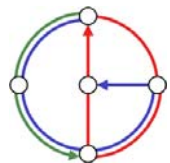

# Networks are complex!



- many “pieces”
  - hosts
  - routers
  - links of various media
  - applications
  - protocols
  - hardware
  - software
- Questions:
  - Is there any hope of organizing the structure of a network?
  - Or at least our discussion of networks?

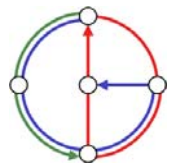

# Organization of air travel

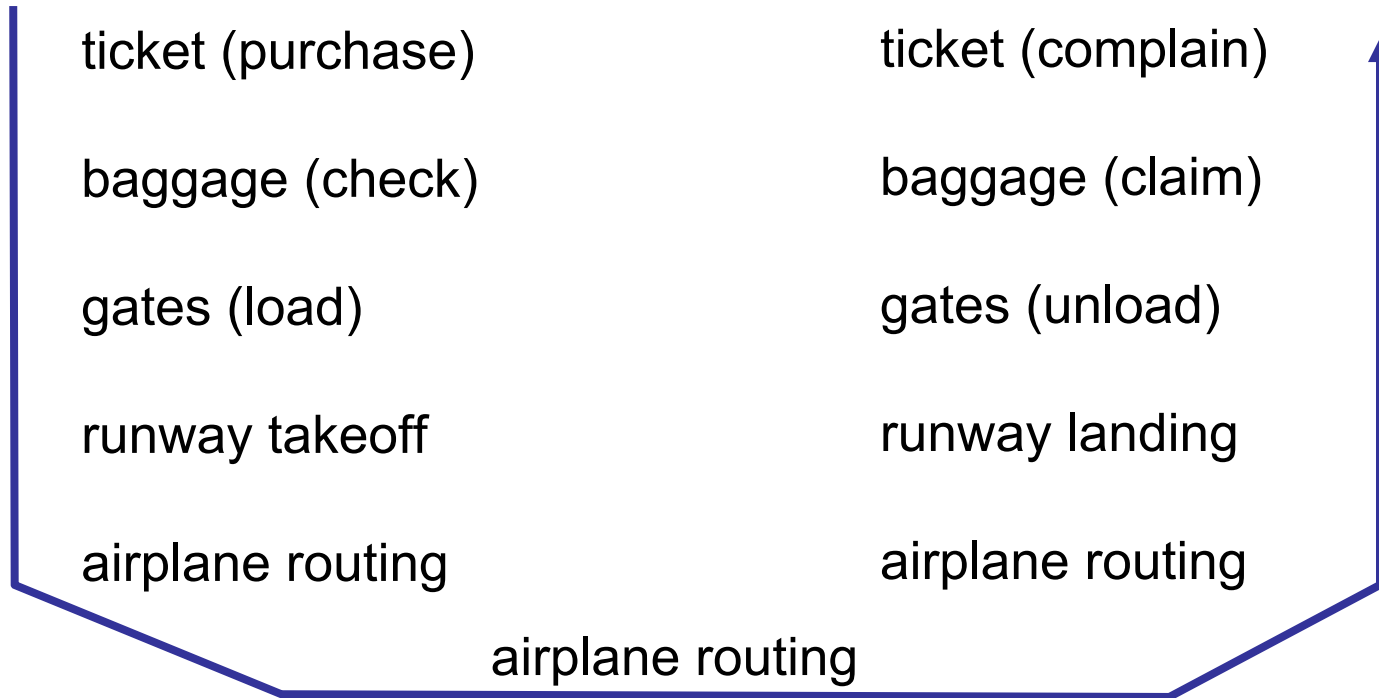

ticket (purchase)

baggage (check)

gates (load)

runway takeoff

airplane routing

ticket (complain)

baggage (claim)

gates (unload)

runway landing

airplane routing

airplane routing

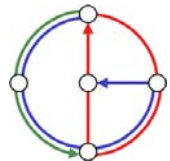

# Organization of air travel: a different view



ticket (purchase)	ticket (complain)
baggage (check)	baggage (claim)
gates (load)	gates (unload)
runway takeoff	runway landing
airplane routing	airplane routing
airplane routing	

- Layers: each layer implements a service
  - via its own internal-layer actions
  - relying on services provided by layer below

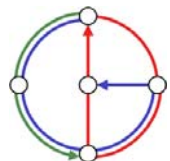

# Layered air travel: services



Counter-to-counter delivery of person+bags

baggage-claim-to-baggage-claim delivery

people transfer: loading gate to arrival gate

runway-to-runway delivery of plane

airplane routing from source to destination

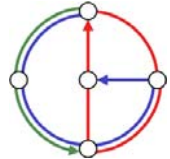



# Distributed implementation of layer functionality



Departing airport

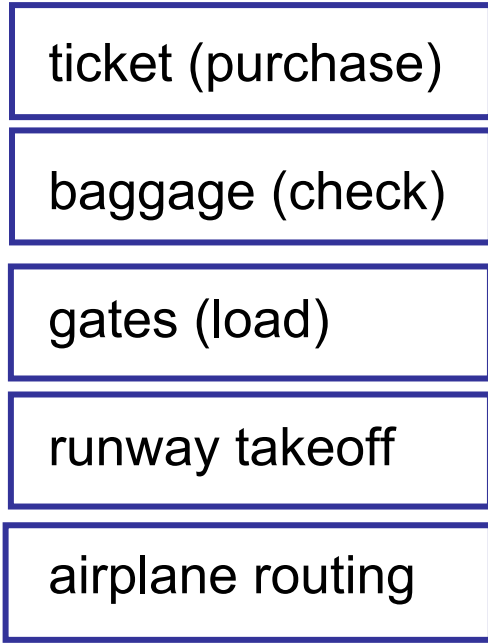

Arriving airport

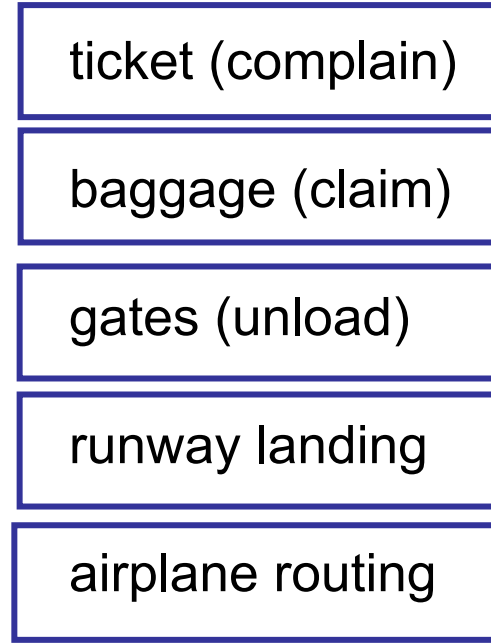

intermediate air traffic sites

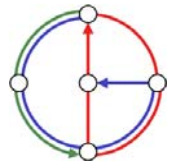
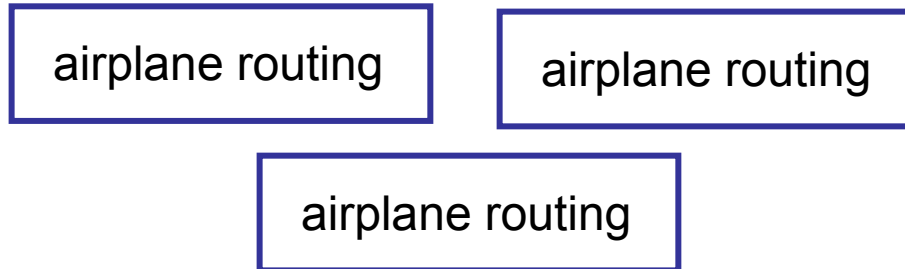

# Another example of layering

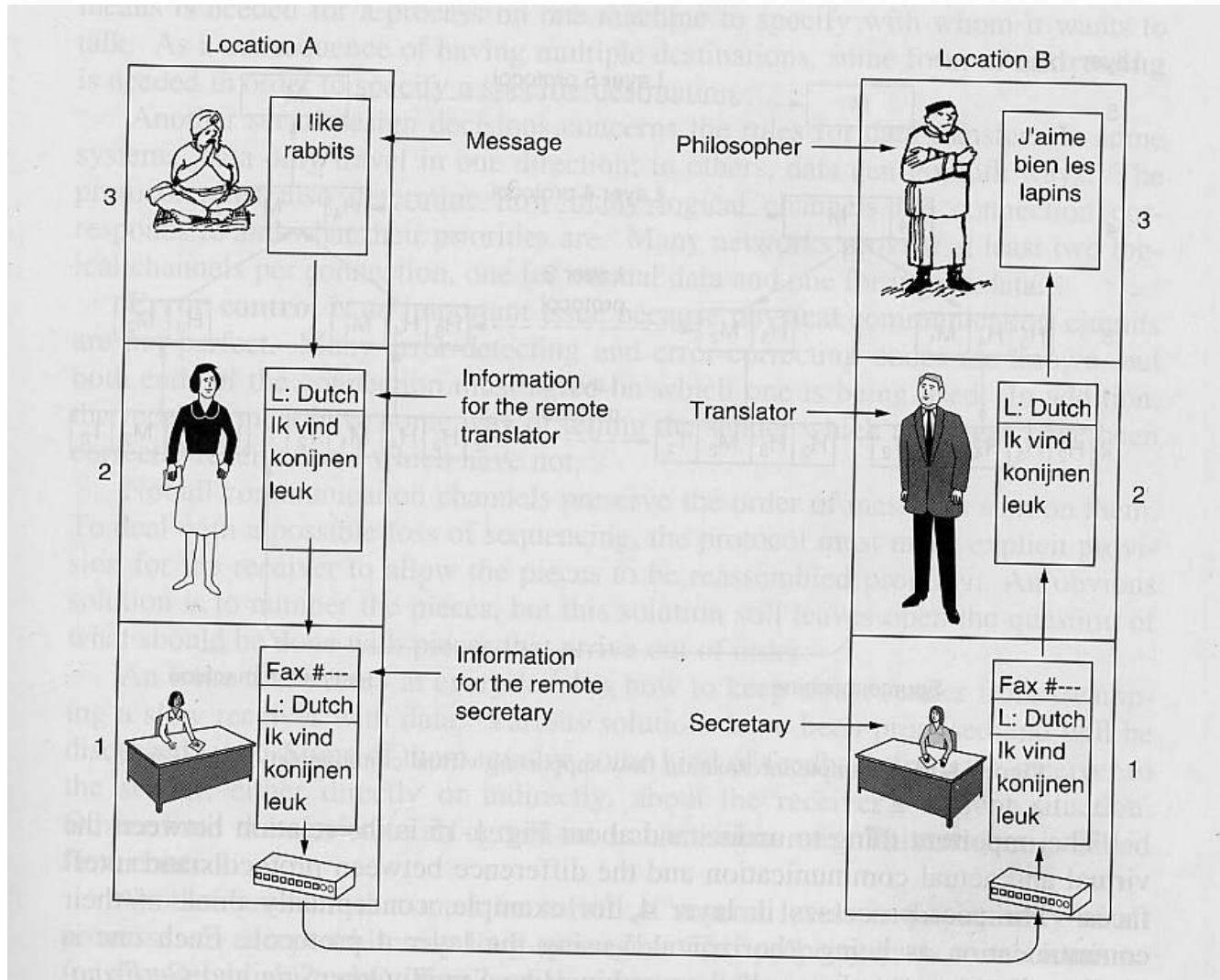

[Tanenbaum]

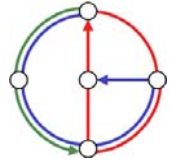

# Why layering?



- Dealing with complex systems
- Explicit structure allows identification, relationship of complex system's pieces
  - layered reference model for discussion
- Modularization eases maintenance, updating of system
  - change of implementation of layer's service transparent to rest of system
  - e.g. change in gate procedure doesn't affect rest of system

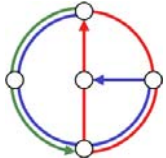

# Internet protocol stack (TCP/IP reference model)



- **application:**
  - ftp, SMTP, http
- **transport:** host-host data transfer
  - TCP, UDP
- **network:** routing of datagrams from source to destination
  - IP, routing protocols
- **link:** data transfer between neighboring network elements
  - PPP, Ethernet
- **physical:** bits “on the wire”

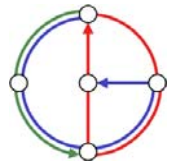
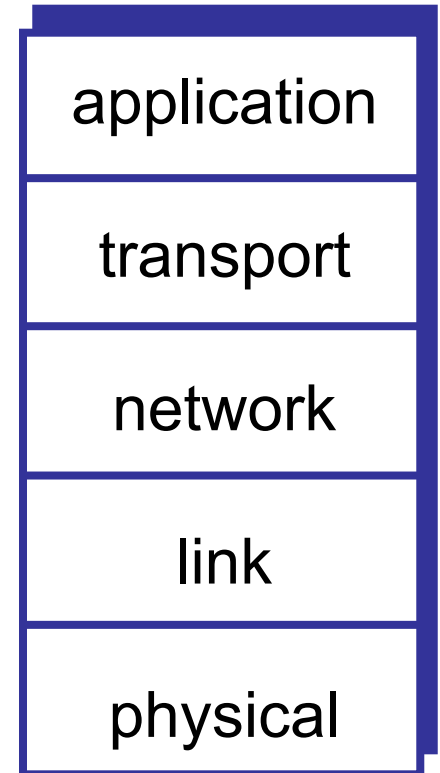

# ISO/OSI Reference Model



- 7 layers instead
  - Application, Presentation, Session, Transport, Network, Data Link, Physical
  - Presentation: Syntax and semantics of information transmitted
  - Session: Long-Term transport, such as checkpointing
- 3 central concepts
  - Service: Tells what the layer does
  - Interface: Tells the process above how to access the layer
  - Protocol: How the service is performed; the layer's own business.
- In this course, we use the Internet reference model

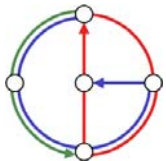

# Layering: logical communication



## Each layer

- distributed
- “entities” implement layer functions at each node
- entities perform actions, exchange messages with peers

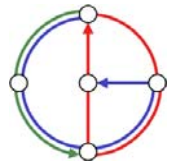
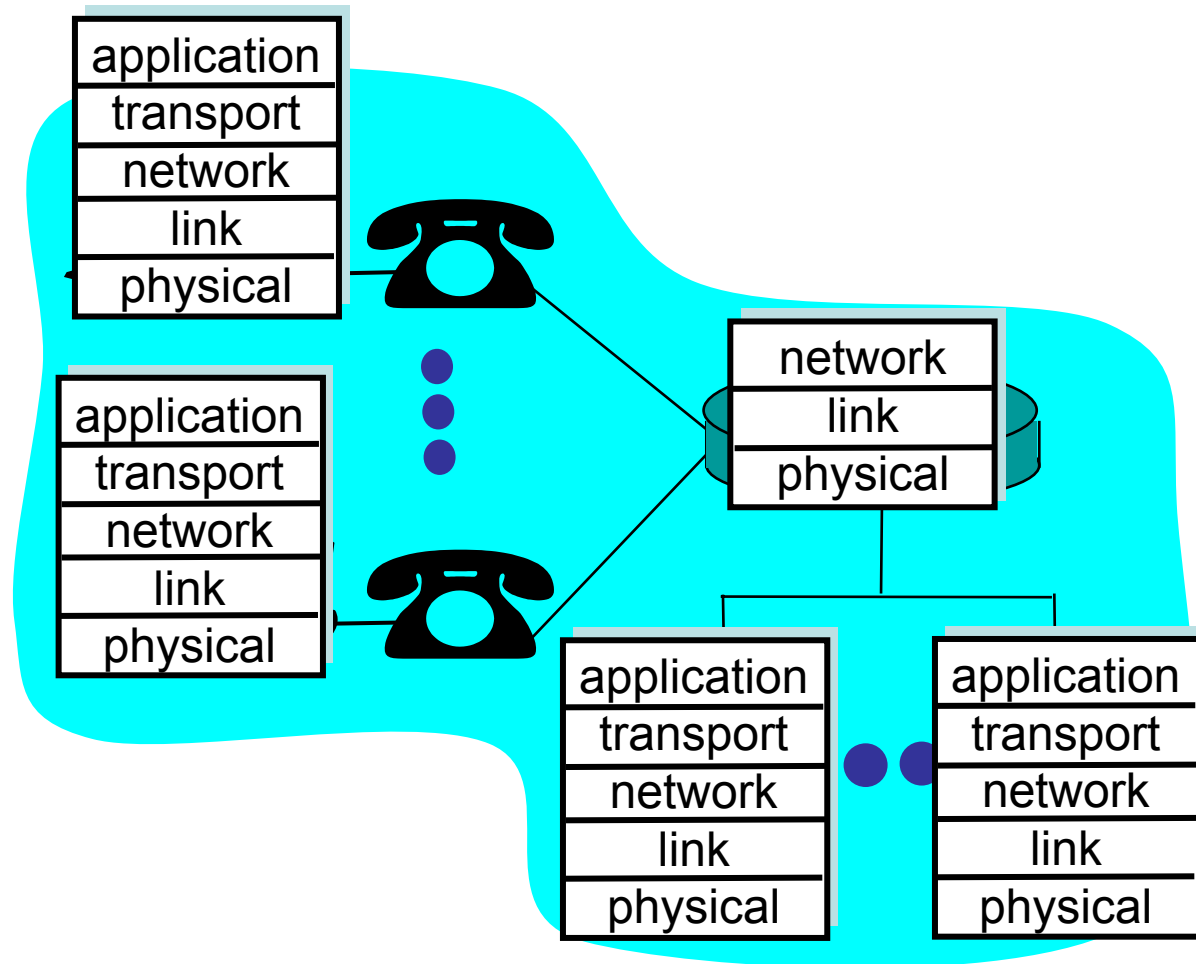

# Layering: *logical* communication

Example: transport

- take data from app
- add addressing, reliability check info to form “datagram”
- send datagram to peer
- wait for peer to ack receipt
- Analogy: post office

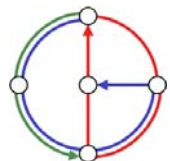
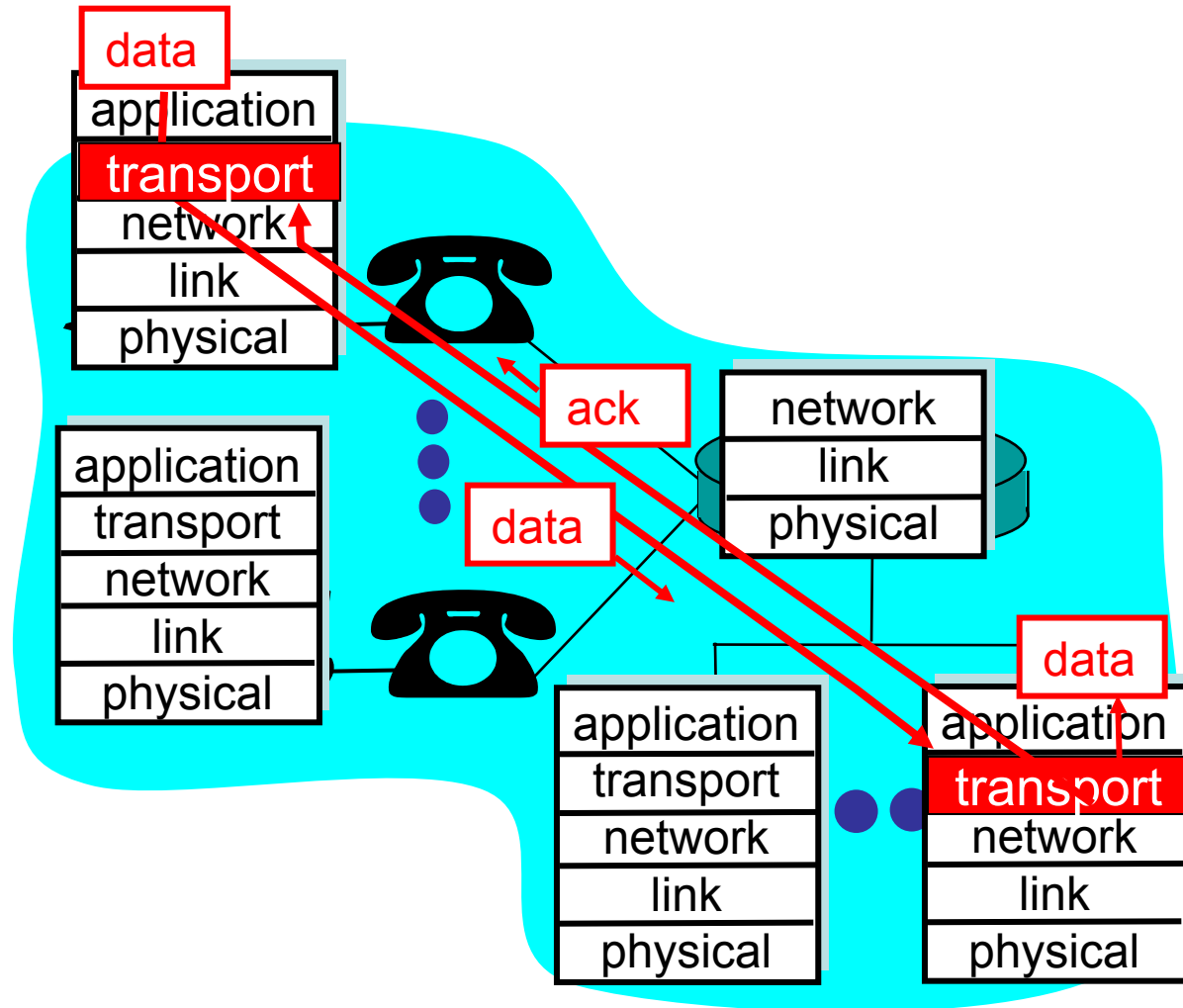

# Layering: *physical* communication

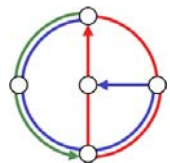
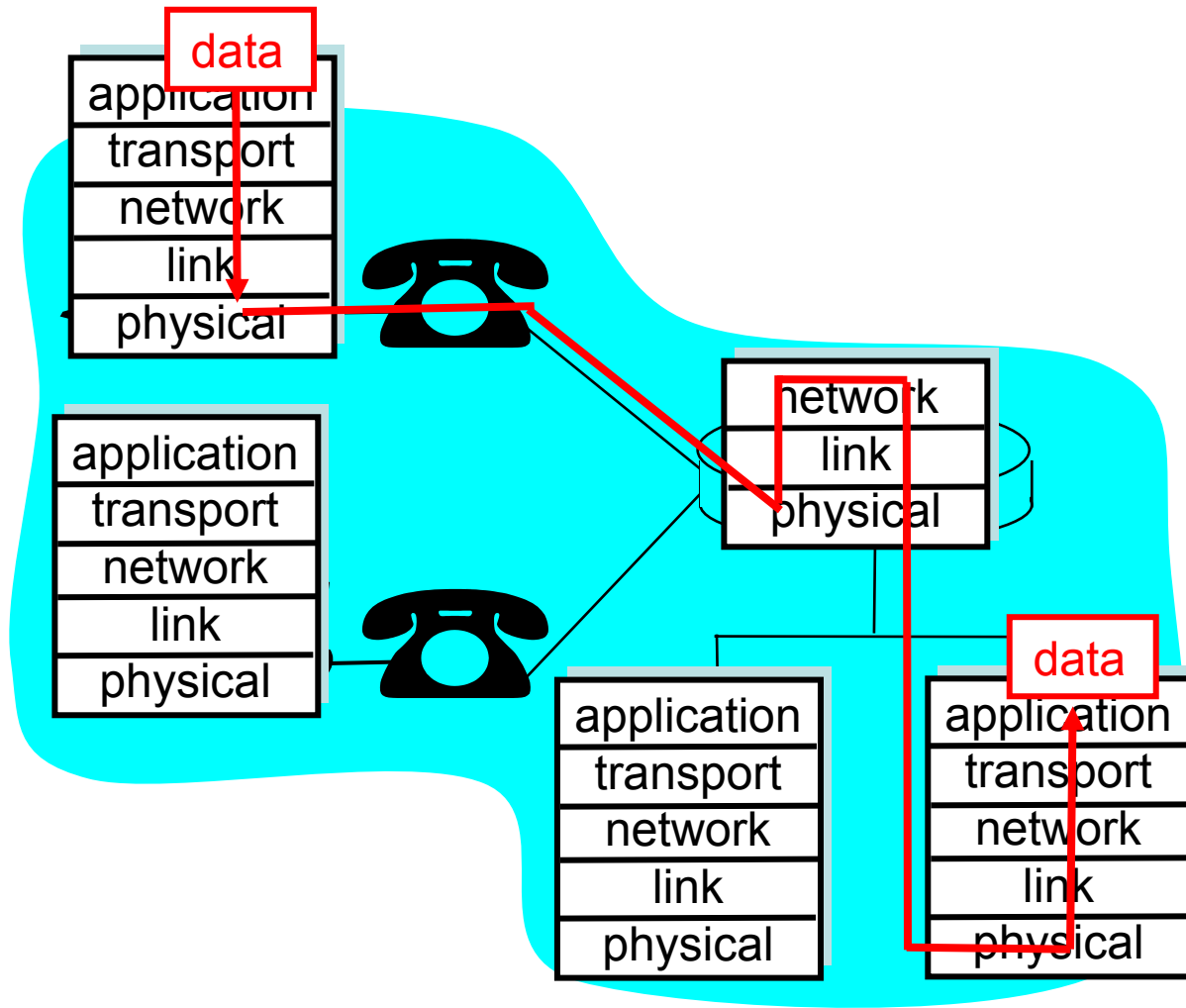



# Protocol layering and data

- Each layer takes data from above
  - adds header information to create new data unit
  - passes new data unit to layer below

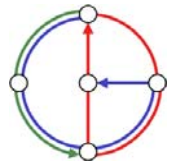
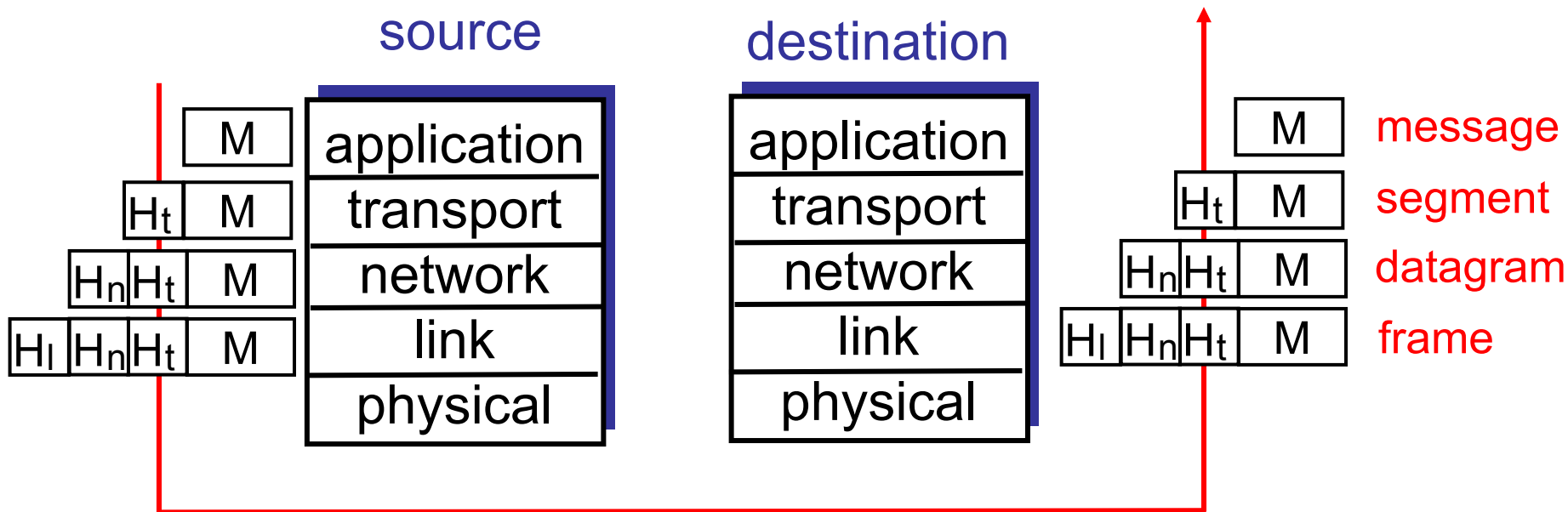

# Internet structure: network of networks



- roughly hierarchical
- national/international backbone providers (NBPs), a.k.a. “tier 1”
  - e.g. UUNet, Sprint, Abovenet, AT&T, BBN/GTE, etc.
  - interconnect (peer) with each other privately, or at public Network Access Point (NAP)
- regional ISPs
  - connect into NBPs
- local ISP, company
  - connect into regional ISPs

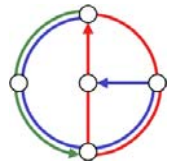
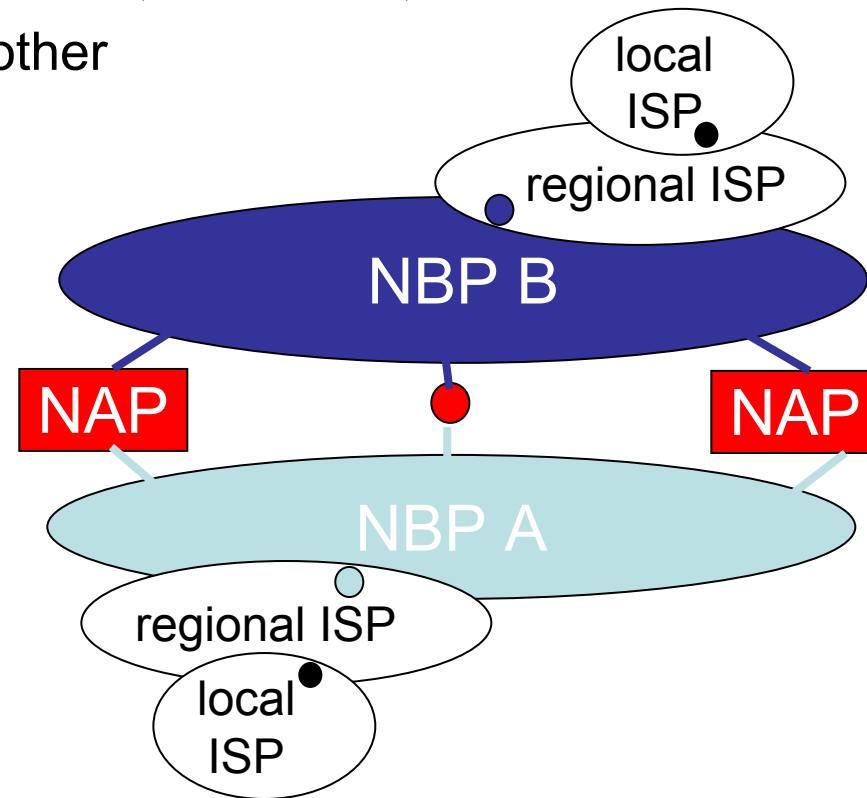

# Network of typical backbone provider



The Gigabit Research Network

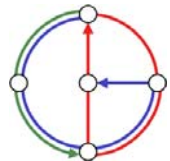
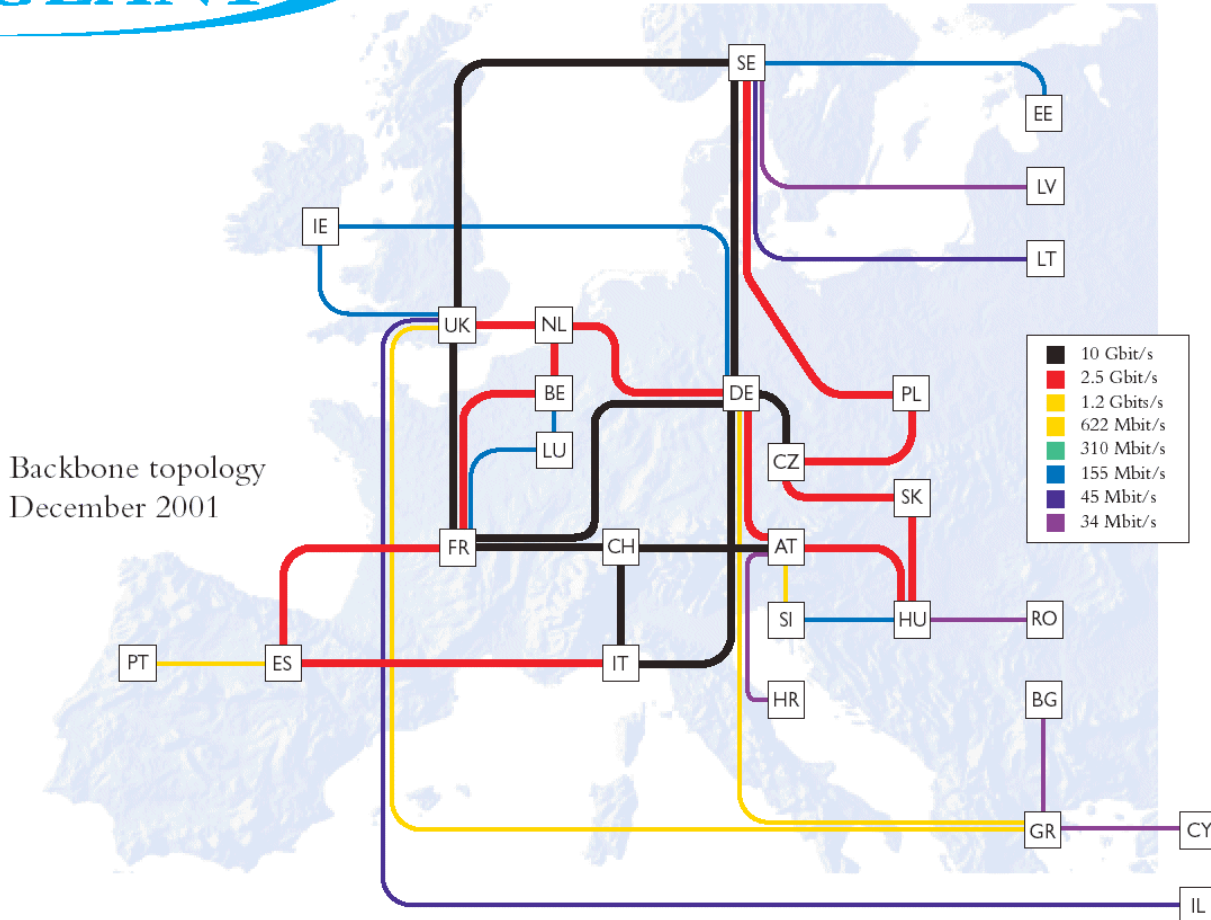

# Zur Geschichte der Kommunikation



- Tontäfelchen (3000 v.u.Z)
- Fackeltelegraphie
  - bereits im 5. Jh. v.u.Z. (Griechenland)
- Briefftauben
  - Spätestens Mittelalter
- Reiterboten
  - Ab 1860
- Trommeln, Spiegel, Flaggen, ...
- Optische Telegraphen
  - Claude Chappe (Frankreich, 1791)
  - Schweiz: ab 1850

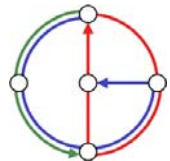
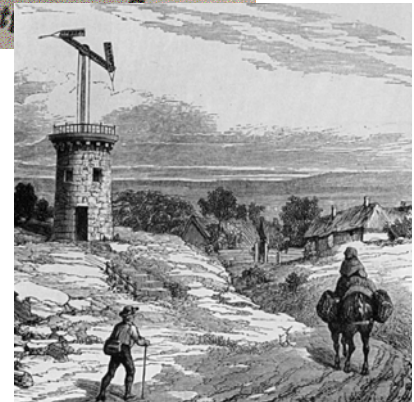
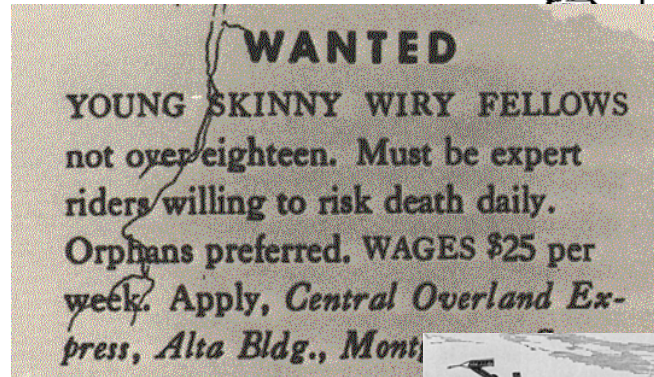

# Protokoll von Polybius (2. Jhd. v.u.Z, Griechenland)



- Alphabet als 5 Gruppen zu 5 oder 4 Zeichen
- 2 Gruppen mit je 5 Fackeln
- Verbindungsaufbau
  1. Sendeabsicht: Heben von 2 Fackeln
  2. Empfangsbereitschaft: Heben von 2 Fackeln
  3. Senken der Fackeln
- Datenübertragung für jedes Zeichen
  1. Linke Fackelgruppe: Zeichengruppe anzeigen
  2. Senken der Fackeln
  3. Rechte Fackelgruppe: Zeichen anzeigen
  4. Senken der Fackeln

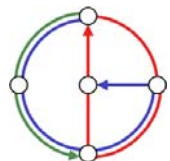
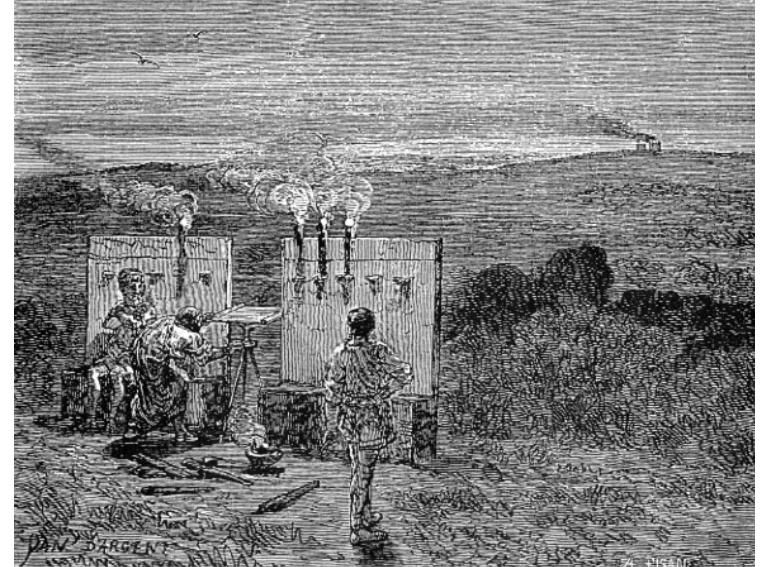

# Protokoll bei Optischen Telegraphen

- Regeln für korrekten Nachrichtenaustausch
- Typischerweise synchrones Protokoll, d.h. sendende Station muss Symbol so lange zeigen, bis es von der empfangenden Station bestätigt wird.
- Es gab ein Fehlersignal, mit dem man wie bei “backspace” das letzte Zeichen löschen konnte.
- Dieses Protokoll erinnert stark an moderne Protokolle.

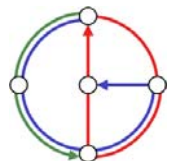
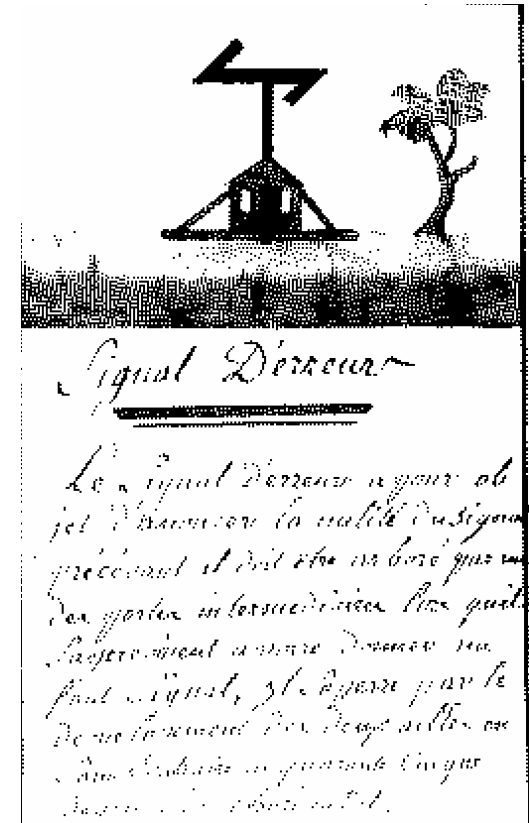



# Elektrische Telegraphen



- 1774: 26 Drähte (unpraktisch)
- 1837: Elektrischer Zeigertelegraph
  - Cooke und Wheatstone
  - 5 Magnetnadeln, jeweils 2 werden abgelenkt und zeigen auf 1 von 20(!) Zeichen
- Man erreicht ca. 25 Zeichen pro Minute
- 1837: Samuel Morse
- 1851: Paris – London
- 1852: 6400km Kabel in England
- 1866: London – New York
  - 20 Wörter kosten \$100
- Eigenständige Industrie

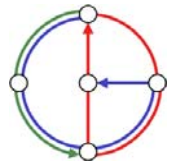
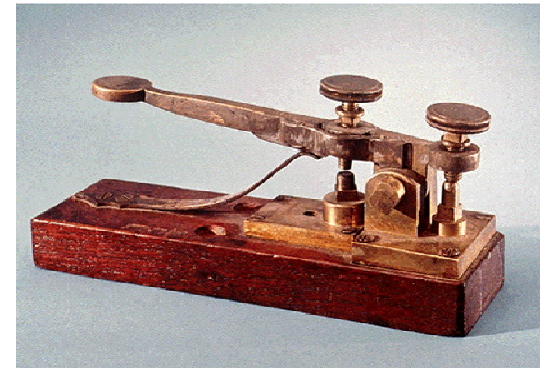
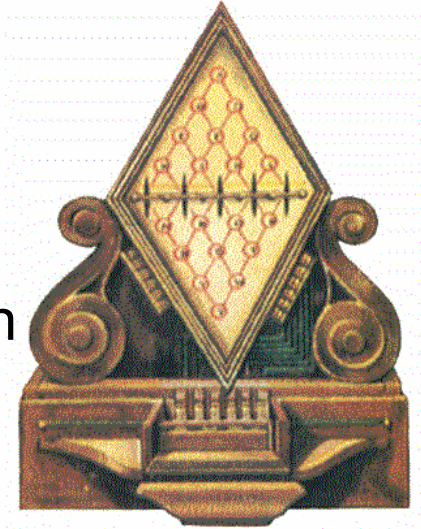

# Telefon



- Reiss (1863), Bell (1876), Edison (1877), Siemens (1878)
- “This ‘phone’ has way to many shortcomings to consider it as a serious way of communicating. The unit is worthless to us.” [Aktenvermerk Western Union, 1876]
- Ab 1880: Öffentliche Telefonnetze
  - Zuerst maximal 30km Ausdehnung

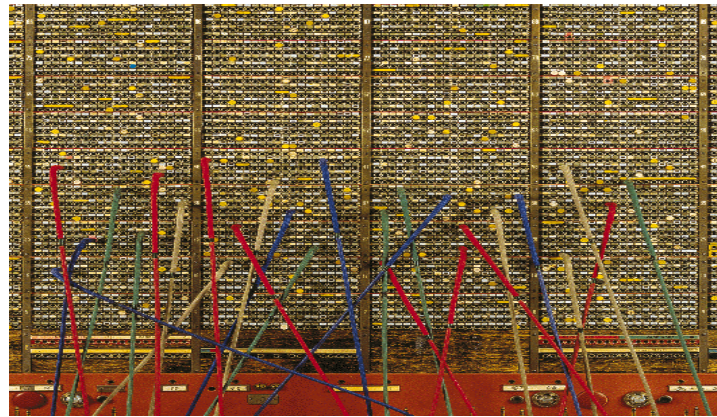

[New York 1895]

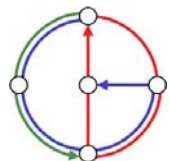



# Wireless Transmission



- 1895: Guglielmo Marconi (1874 – 1937)
  - first demonstration of wireless telegraphy (digital!)
  - long wave transmission, high transmission power necessary ( $> 200\text{kW}$ )
  - Nobel Prize in Physics 1909
- 1901: First transatlantic connection
- 1906 (Xmas): First radio broadcast
- 1907: Commercial transatlantic connections
  - huge base stations (30 100m high antennas)
- 1920: Discovery of short waves by Marconi
- 1928: First TV broadcast
  - Atlantic, color TV

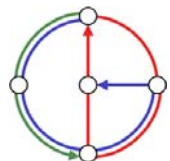

# Weitere historische Meilensteine



- 1964: Nachrichtensatelliten
- 1966: Glasfaser
- 1958 : Erste Analoge Handynetze: Deutsches A-Netz  
– Vergleich PTT (Swisscom) NATEL: 1978 – 1995
- 1982 : Start der GSM Standardisierung
- 1997: Wireless LAN
- ...

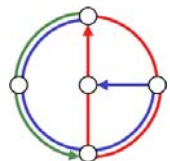

# Internet History 1961-72: Early packet-switching principles

- 1961: [Kleinrock] queuing theory shows effectiveness of packet-switching
- 1964: [Baran] packet-switching in military nets
- 1967: ARPAnet conceived by Advanced Research Projects Agency
- 1969: first ARPAnet node operational, first network with 4 nodes
- 1972
  - ARPAnet demonstrated publicly
  - NCP (Network Control Protocol) first host-host protocol
  - first e-mail program
  - ARPAnet has 15 nodes



MAP 4 September 1971

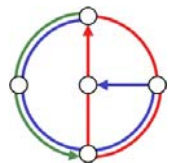

# 1972-80: Internetworking, new and proprietary nets



- 1970: ALOHAnet satellite network in Hawaii
- 1973: Metcalfe's PhD thesis proposes Ethernet
- 1974: [Cerf and Kahn] architecture for interconnecting networks
- Late 70's:
  - proprietary architectures: DECnet, SNA, XNS
  - switching fixed length packets (ATM precursor)
- 1979: ARPAnet has 200 nodes
- Vinton G. Cerf and Robert E. Kahn's (Ehrendoktoren der ETH seit 1998) internetworking principles:
  - minimalism
  - autonomy
  - no internal changes required to interconnect networks
  - best effort service model
  - stateless routers
  - decentralized control
  - define today's Internet architecture

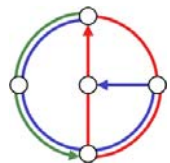

# 1980-90: new protocols, a proliferation of networks



- 1983: deployment of TCP/IP
- 1982: SMTP e-mail protocol defined
- 1983: DNS defined for name-to-IP-address translation
- 1985: FTP protocol defined
- 1988: TCP congestion control
- new national networks: NSFnet, CSNET, BITnet, Minitel
- 100,000 hosts connected to confederation of networks

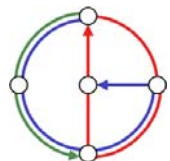

# 1990's: Commercialization, WWW

- Early 1990's: ARPAnet decommissioned
- 1991: NSF lifts restrictions on commercial use of NSFnet (decommissioned, 1995)
- early 1990s: WWW
  - hypertext [Bush 1945, Nelson 1960's]
  - HTML, http: Berners-Lee
  - 1994: Mosaic, later Netscape
  - late 1990's commercialization of the WWW
- Late 1990's
  - est. 50 million computers on Internet
  - est. 100 million+ users
  - backbone links running at 1 Gbps

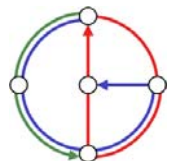
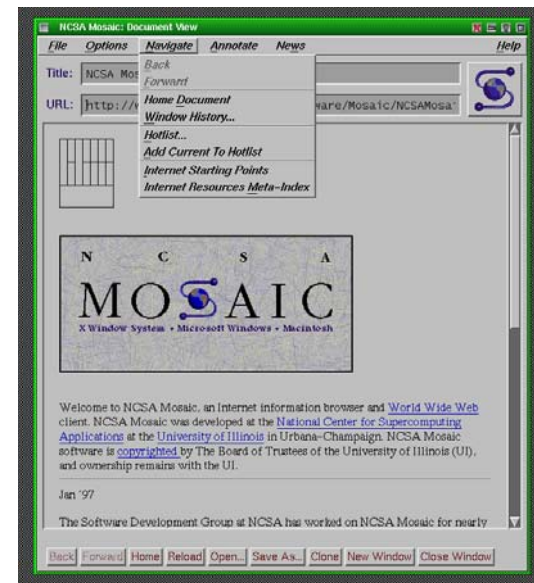

# Number of hosts in the Internet (lower bound)



## Internet Domain Survey Host Count

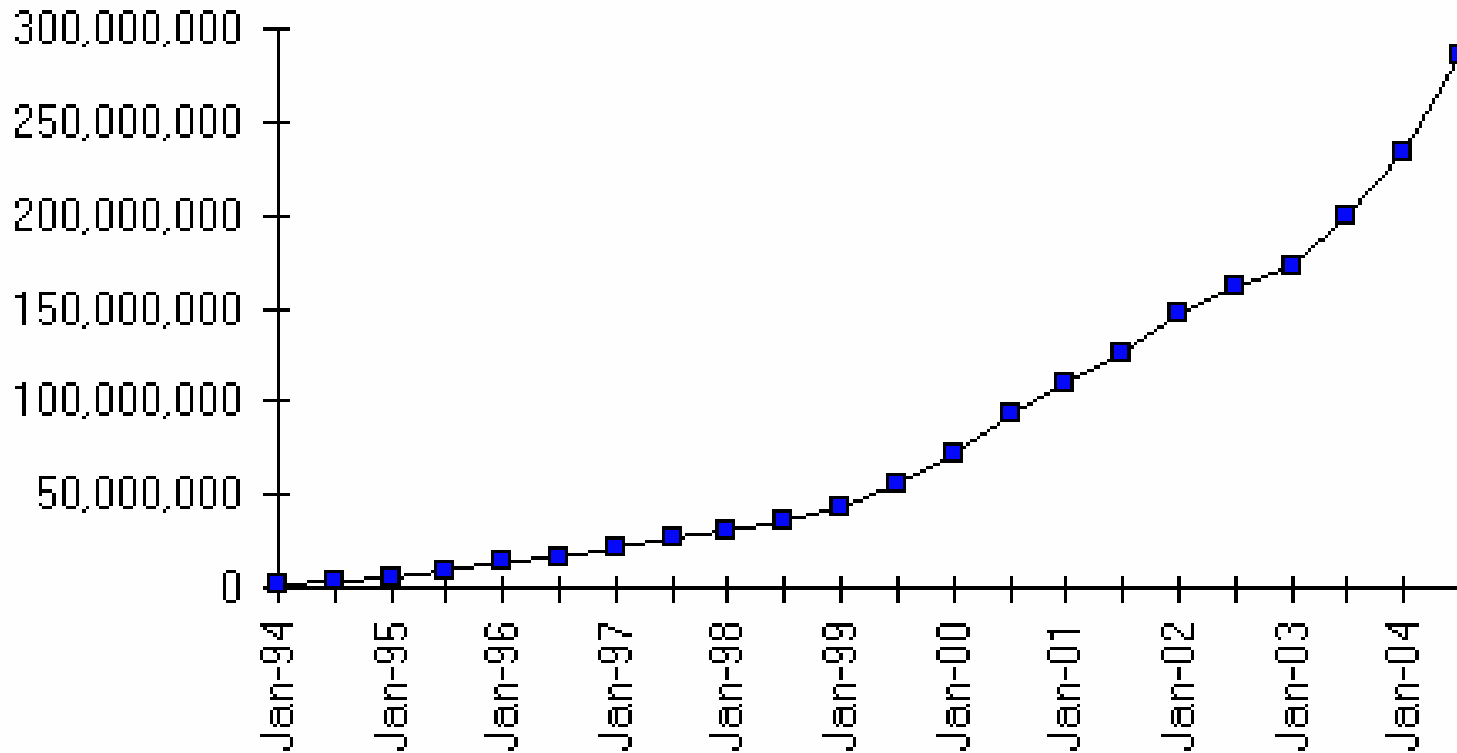

Source: Internet Software Consortium ([www.isc.org](http://www.isc.org))

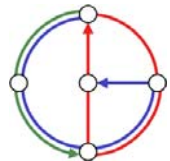



# Internet Providers by “size” and “region”



copyright ©2002 UC Regents. all rights reserved.

**SKITTER**  
AS INTERNET GRAPH

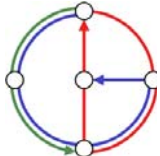
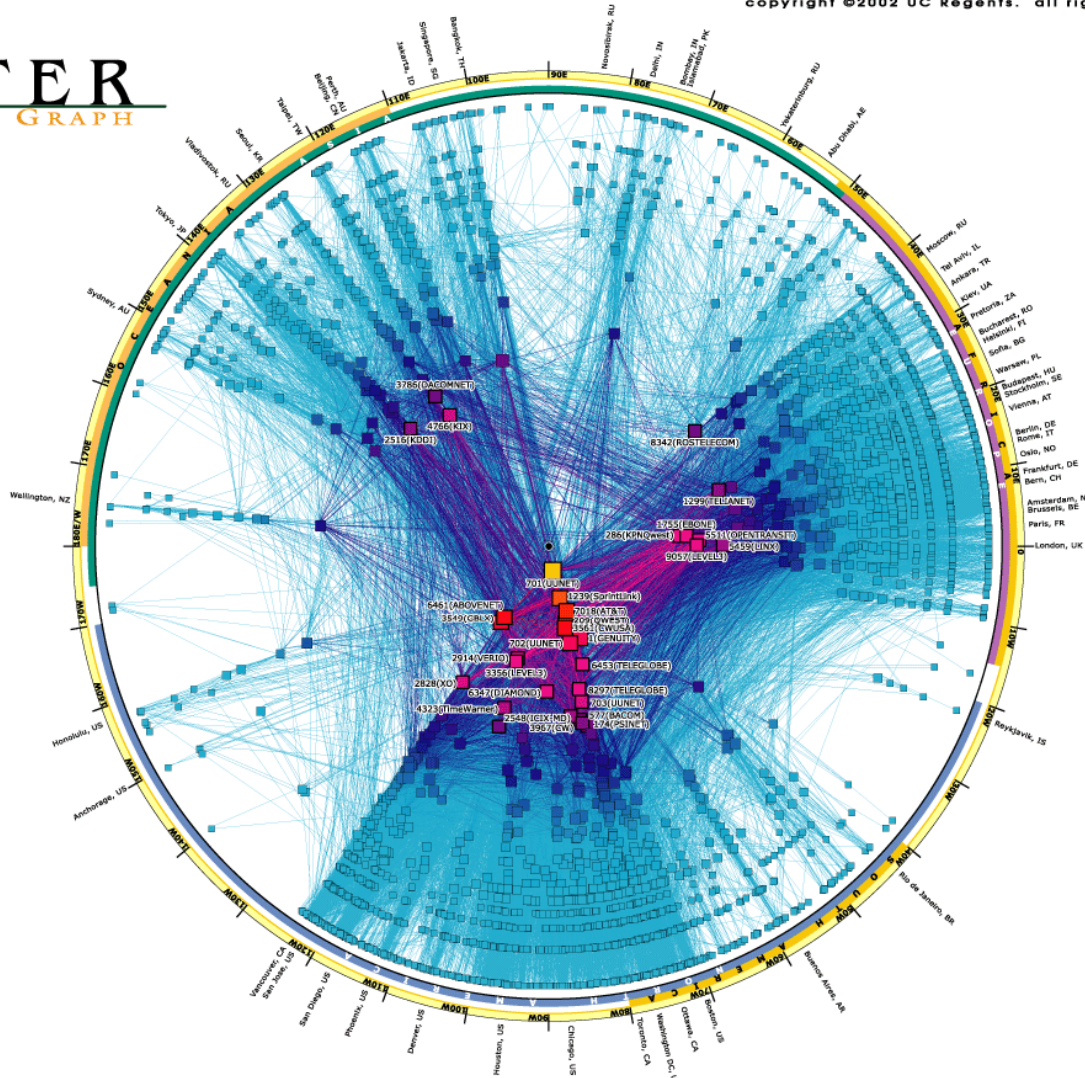
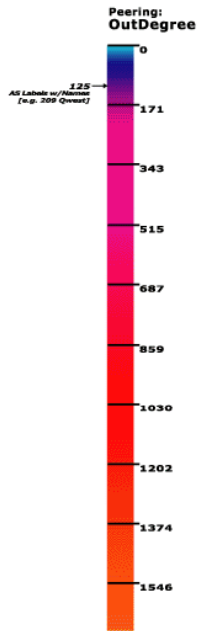



# Internet Topology

The image depicts the Internet topology. It shows 535,000-odd Internet nodes and over 600,000 links. The nodes, represented by the yellow dots, are a large sample of computers from across the whole range of Internet addresses.

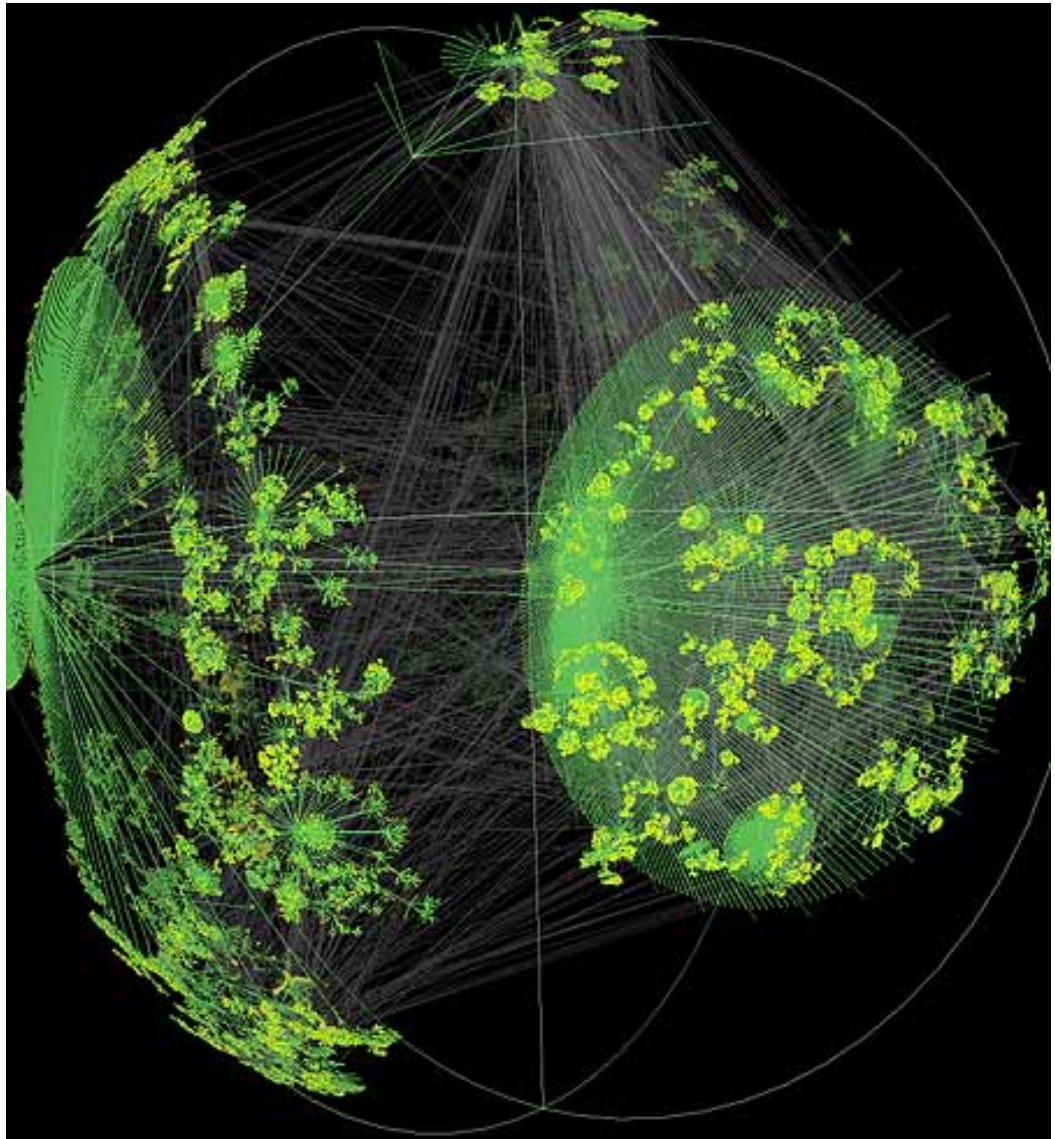

[<http://www.cybergeography.org/atlas/topology.html>]

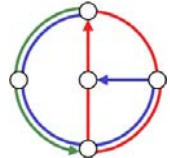

# More Internet Topology

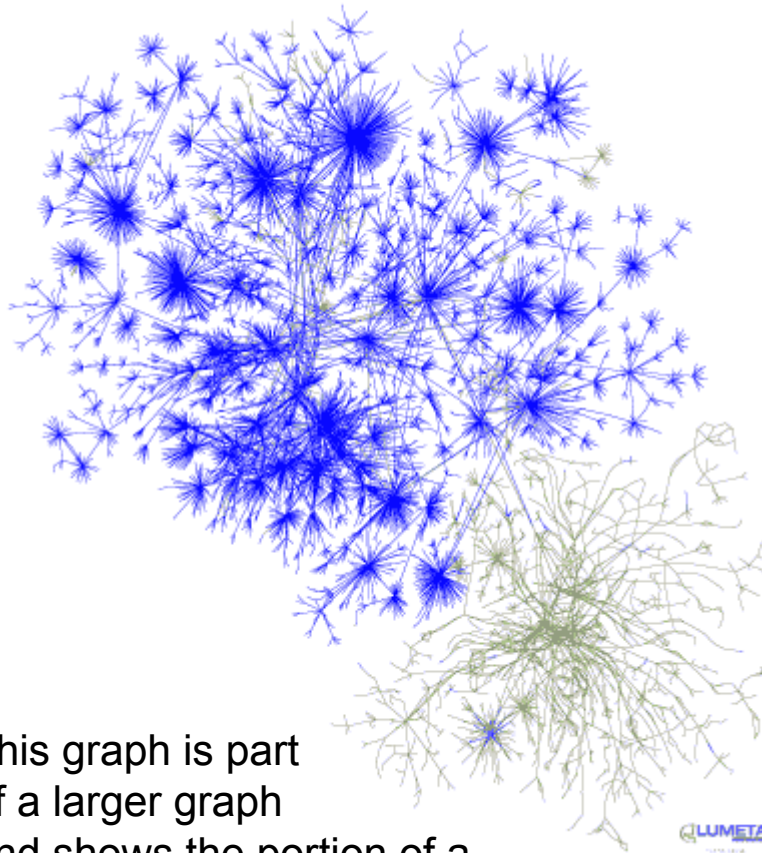

This graph is part of a larger graph and shows the portion of a corporate Intranet that is 'leaking' with the Internet.

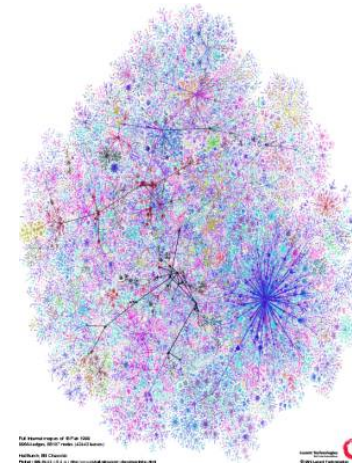

This graph shows the router level connectivity of the Internet.

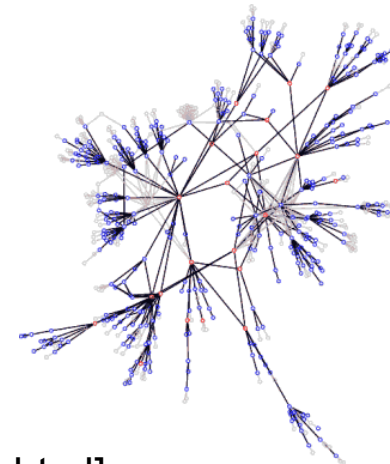

A topology map of a core network of a medium-sized ISP.

[<http://www.cybergeography.org/atlas/topology.html>]

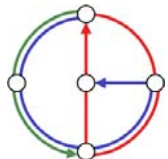

# The SWITCH network

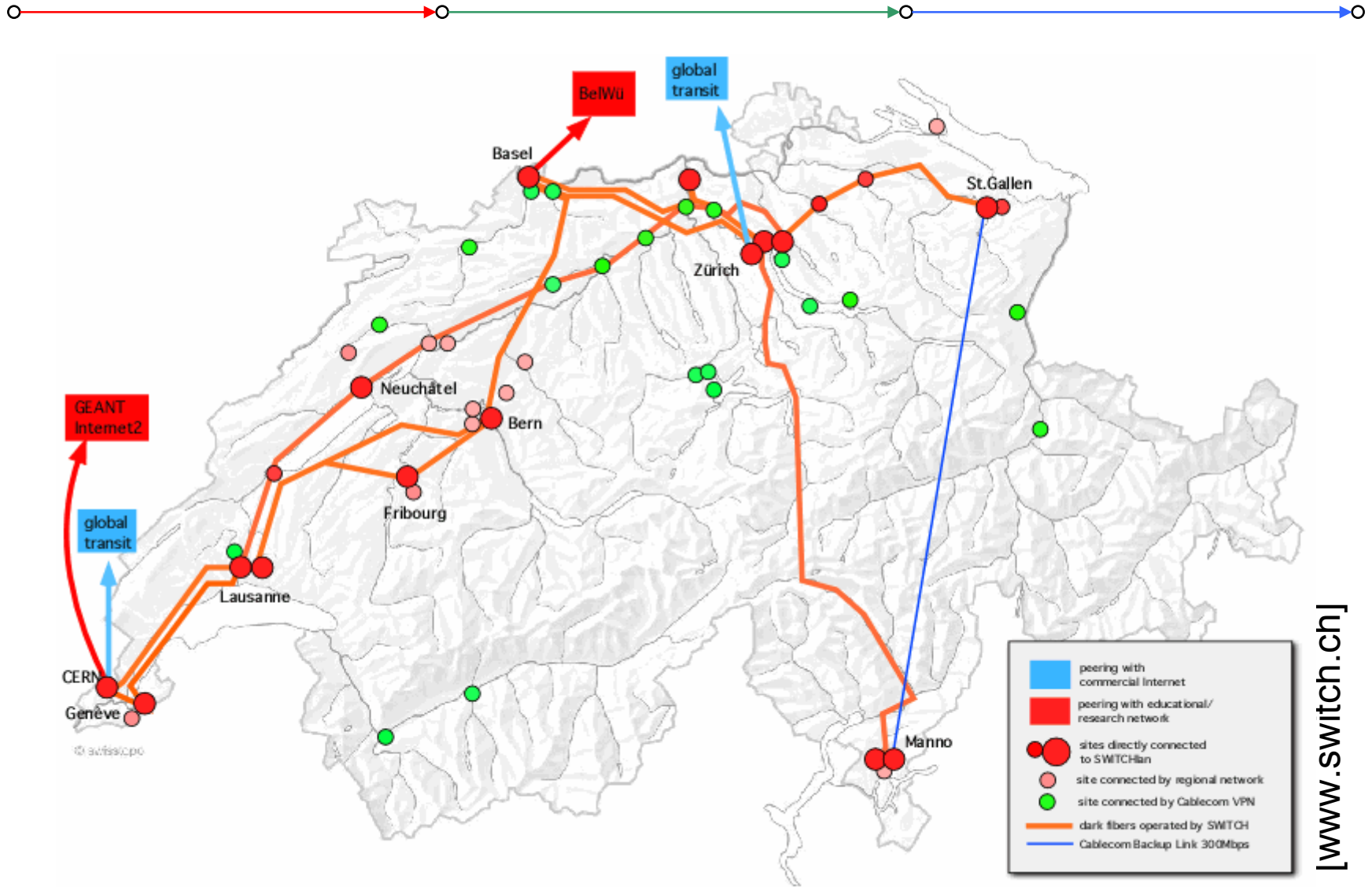

www.switch.ch

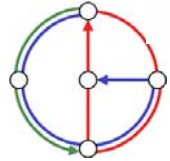

©SWITCH, 20040229



# KPNQwest network as planned before collapse...



“The pan European KPNQwest network, when complete, will connect major cities together by six high-capacity backbone rings.”

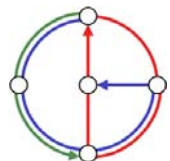

# Internet Users Worldwide

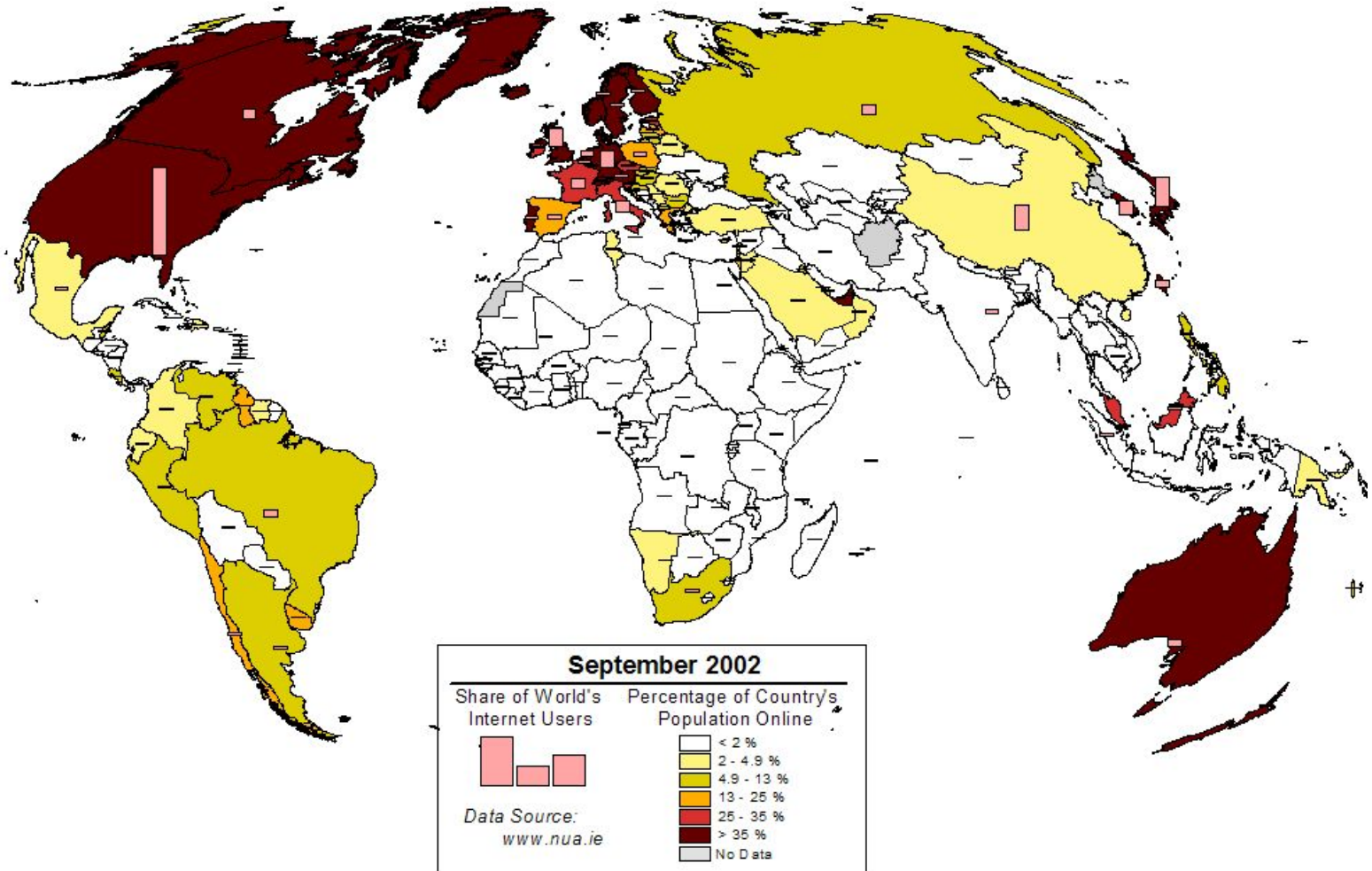

Copyright 2003, Matthew Zook  
<http://www.zooknic.com/>

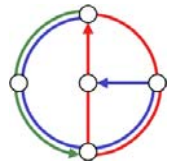

# Global Online Population

## Worldwide Internet Population 2002

445.9 million (eMarketer)

533 million (Computer Industry Almanac)

## Projection for 2004

709.1 million (eMarketer)

945 million (Computer Industry Almanac)

Nation	Population	Internet Users (Source)	Active Users (Nielsen/NetRating)	ISPs
Brazil	174.5 million	6.1 million	6.0 million	50
China	1.3 billion	33.7 million	N/A	3
Germany	83 million	26 million	15.1 million	123
Switzerland	7.3 million	3.4 million	1.8 million	44
Sudan	36 million	10,000	N/A	1
United States	278 million	149 million	102.0 million	7,800

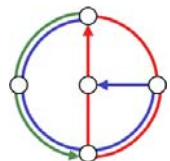

# Internet Languages & Searches

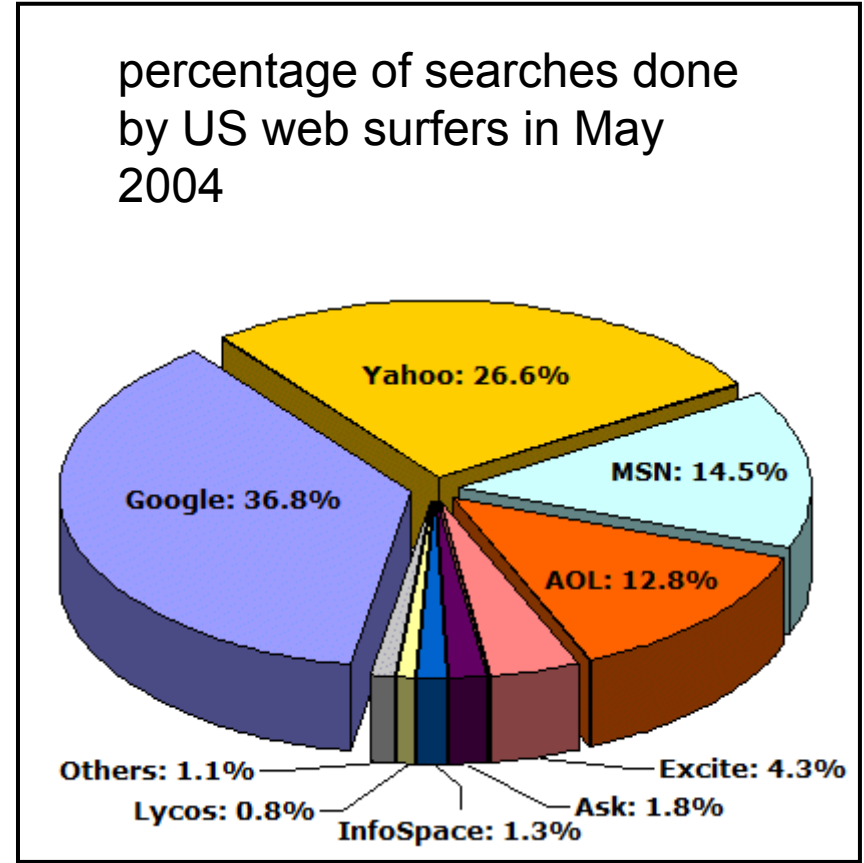
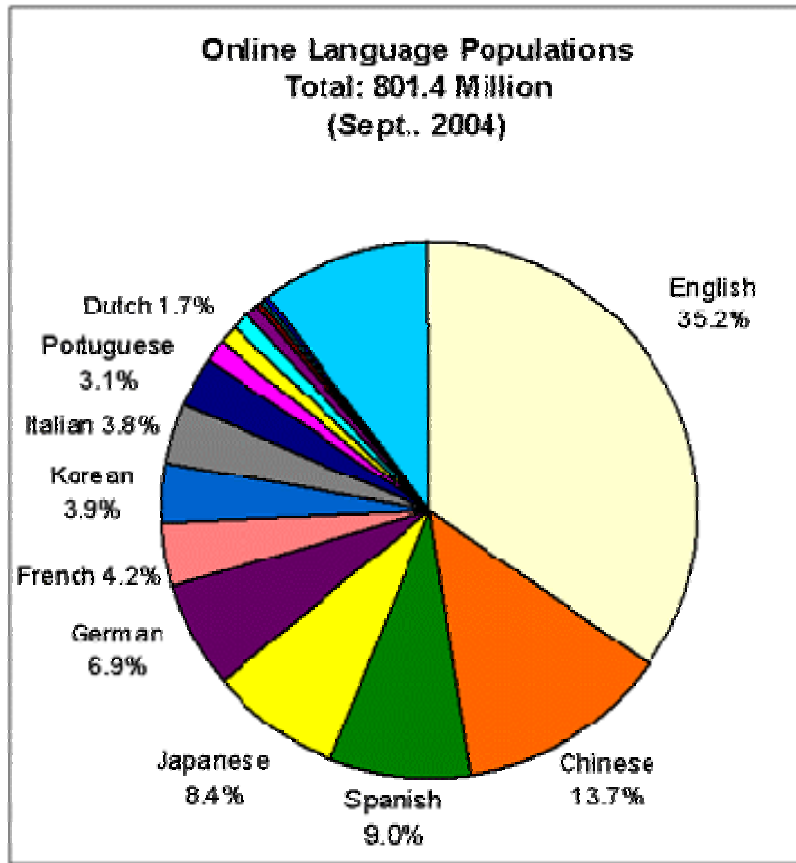

[<http://www.glgreach.com/globstats/index.php3>]

[<http://searchenginewatch.com/reports/article.php>]

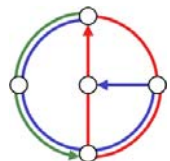

# Favorite Web Sites in Switzerland



- According to Jupiter Media Metrix, 2.022 million visitors used the Internet in Switzerland in February 2001 for an average of 9.5 days.
- On an average day, 680'000 visitors went online for 33 minutes and viewed 27 unique pages.
- Global sites from Microsoft, Yahoo, AOL and Lycos found under the top rankings in all three language regions. National domains are very strong. Bluewin.ch tops the list with an overall reach of 50 percent. Other national sites among the top 20 domains include Search.ch (22 percent reach), SBB.ch (15.5 percent), Sunrise.ch (11.8 percent), Swissonline.ch (10.2 percent) and UBS.com (9.9 percent).

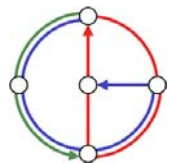



# Internet Usage in Switzerland

Internetnutzung in der Schweiz, Entwicklung 1997-2001

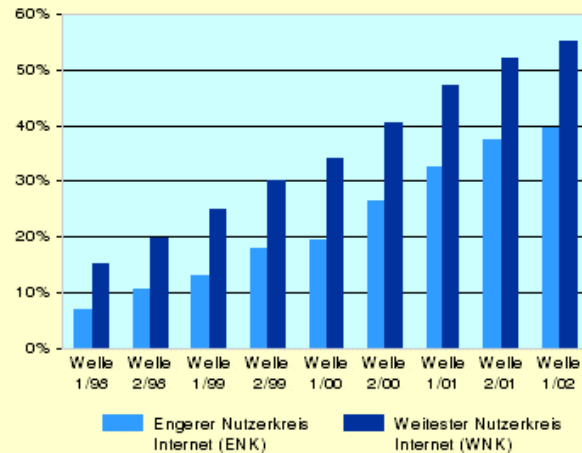

© OFS / BFS / UST

Internetnutzung in der Schweiz nach Bildungsstand, Entwicklung 1997-2001

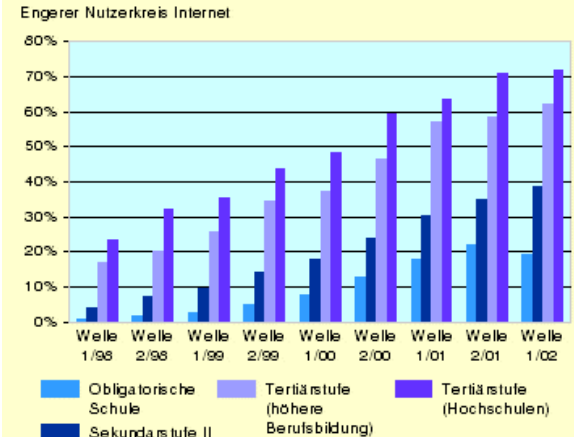

© OFS / BFS / UST

Internetnutzung in der Schweiz nach Einkommen, Entwicklung 1997-2001

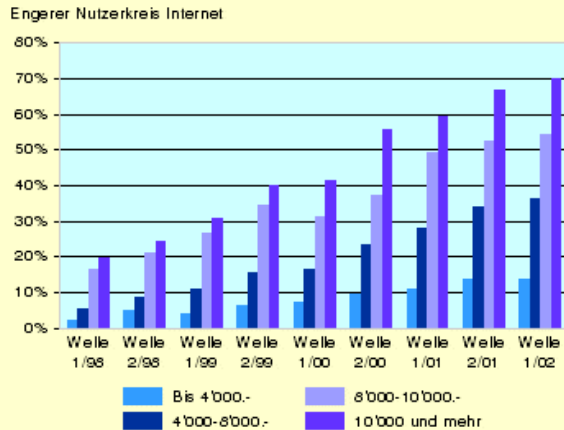

© OFS / BFS / UST

Internetnutzung in der Schweiz nach Alter, Entwicklung 1997-2001

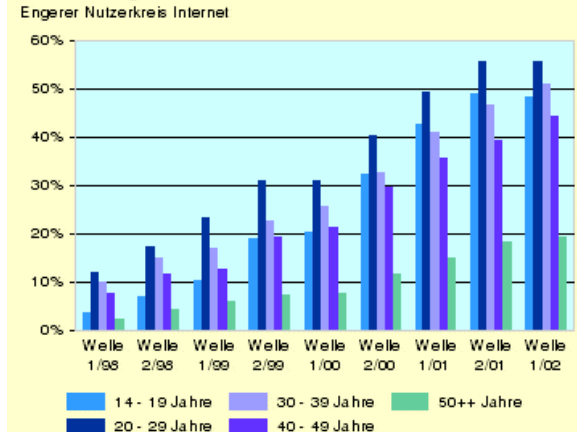

© OFS / BFS / UST

[http://www.statistik.admin.ch]

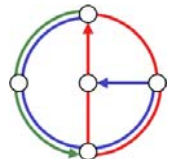

# Internet Usage in Switzerland 2

## Internetnutzung in der Schweiz nach Nutzungszwecken, 2001

Basis: Engerer Nutzerkreis (Mind. ein Mal pro Woche Nutzung des Internets für die jeweiligen Zwecke)

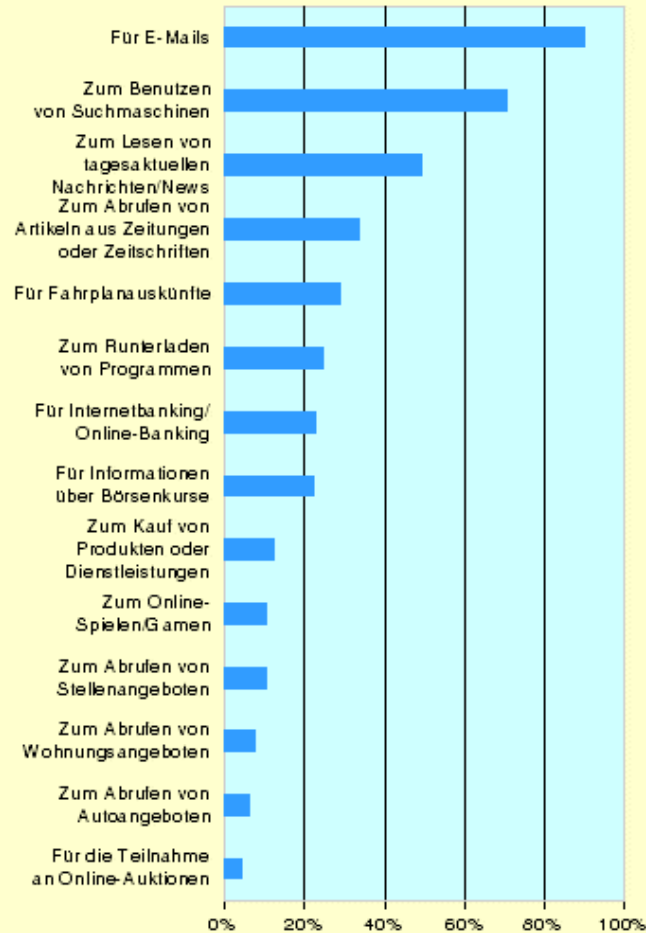

© OFS / BFS / UST

## Internetnutzung in der Schweiz nach Geschlecht, Entwicklung 1997-2001

Engerer Nutzerkreis Internet

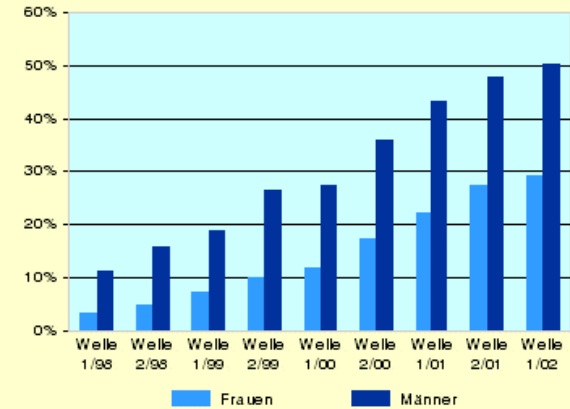

© OFS / BFS / UST

## Internetnutzung in der Schweiz nach Nutzungsort, Entwicklung 1997-2001

Engerer Nutzerkreis Internet

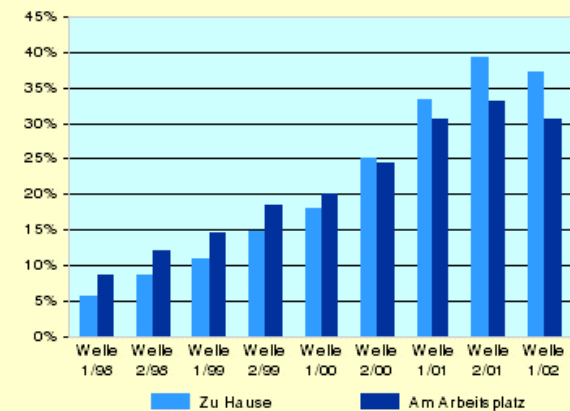

© OFS / BFS / UST

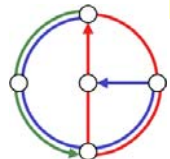

# Domain Names ending in .ch

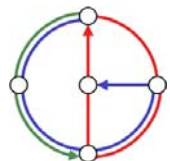
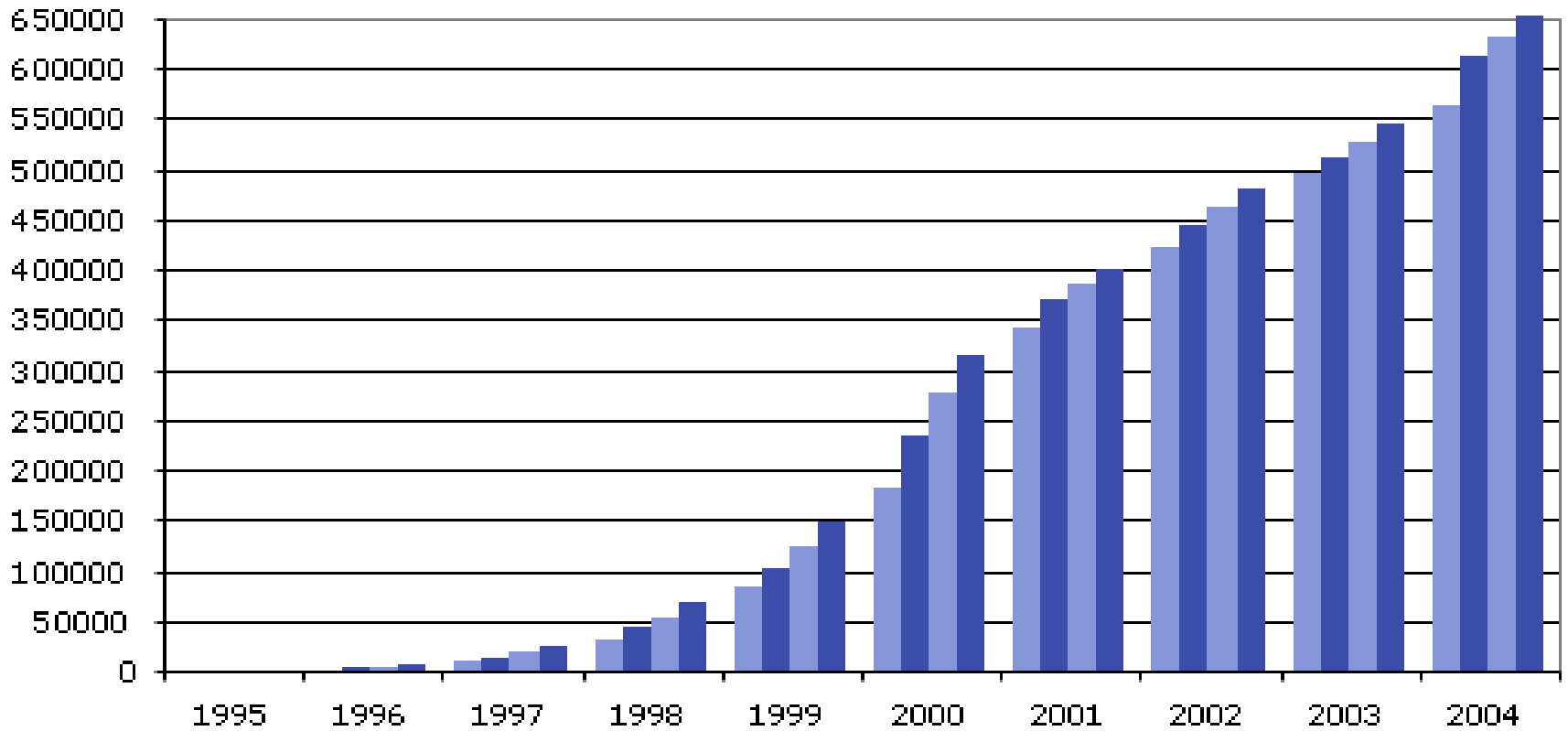

# The “Dot-Com Bubble”



Period : Oct-16-1998 - Oct-16-2003

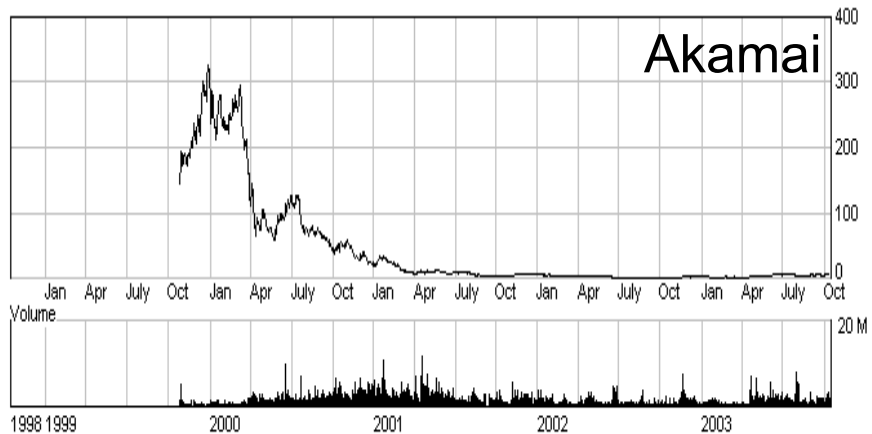

Period : Oct-16-1998 - Oct-16-2003

- Not all Internet companies are subject to the bubble. Some major ones are doing quite well (Cisco, MS, IBM, etc.)
- Many of my fellow students work in the networking or distributed systems area (not that this is a representative subset)
- *Networking still important*

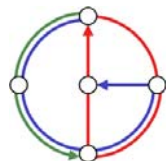

# SPIEGEL: "Neustart im Netz"

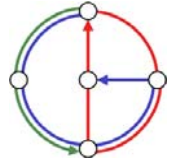

# Course overview: Lectures and Exercises



Introduction	<i>Intro</i>
Overview	
Applications: Email, WWW, etc.	<i>Layer 5</i>
More Applications and Sockets	
Transport Layer: UDP and TCP	<i>Layer 4</i>
Advanced Transport Layer	
Network Layer: Routing Basics	<i>Layer 3</i>
Advanced Network Layer	
Link Layer: Aloha, etc.	<i>Layer 2</i>
Link Layer: Ethernet, Hubs, etc.	
Physical Layer, Wireless	<i>Layer 1</i>
Peer-to-Peer Computing	
Distributed Systems	
Mobile Systems	<i>Special Topics</i>
(Gustavo Alonso)	

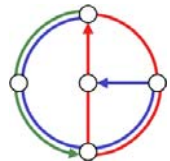



# Literature

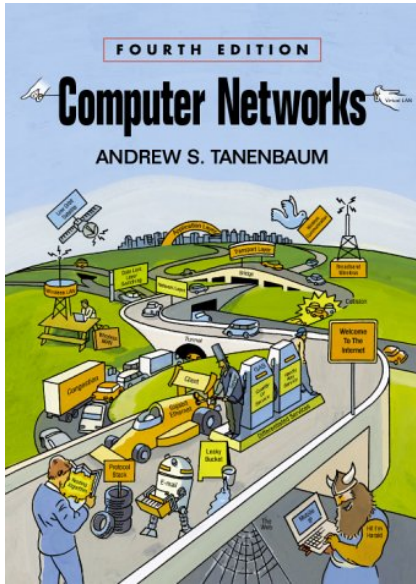

Course book  
Andrew S. Tanenbaum  
Computer Networks  
*Fourth Edition*

German version  
also available



There are alternatives, for example Kurose/Ross

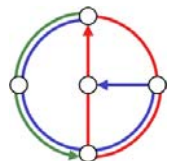
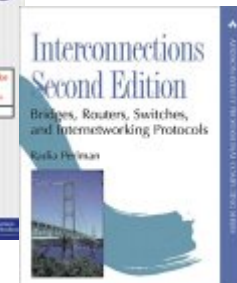
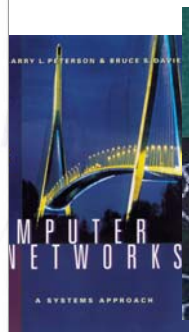
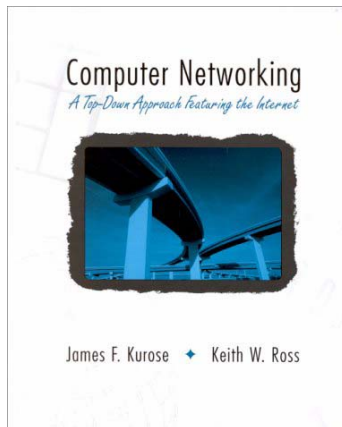

# Organisation



- Übung jeweils Freitag von 13.15 bis 15.00
- Theoretische (Papier) und Praktische (Programmier) Übungen
- Übungen in Gruppen von maximal 2 (T) bis 4 (P) Leuten abgeben
- Erste Übung: Eintragen in Übungsgruppe (online!)
  
- Vorlesung im Vergleich zum letzten Jahr:  
Erster Teil ähnlich, zweiter Teil ganz neu!
  
- Alle weiteren Informationen auf dem Web:  
<http://www.dcg.ethz.ch>
  
- Besuchen Sie unsere Webseite. Wir haben tolle Semesterarbeiten!

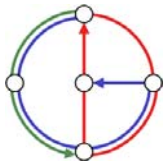



# Prüfungen



- Zwischenprüfung
  - Freitag, 13. Mai(!), 13.15, in der Übungsstunde
  - 30 Minuten schriftlich
  - Keine Hilfsmittel
  - Stoff: Kapitel 1 und 2 (insbesondere Programmierung)
  - Notenanteil: 20%
  
- Semesterendeprüfung
  - Datum wird noch festgelegt
  - 2 Stunden schriftlich
  - Hilfsmittel: Zwei handgeschriebene A4-Seiten, nicht programmierbarer Taschenrechner
  - Stoff: Alles (ungefähr 50% Wattenhofer, 50% Alonso)
  - Notenanteil: 80%
  - Repetenten nach altem Studienplan: Siehe alter Studienplan

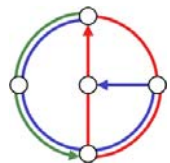

# Other Courses, Master\* in Distributed Systems

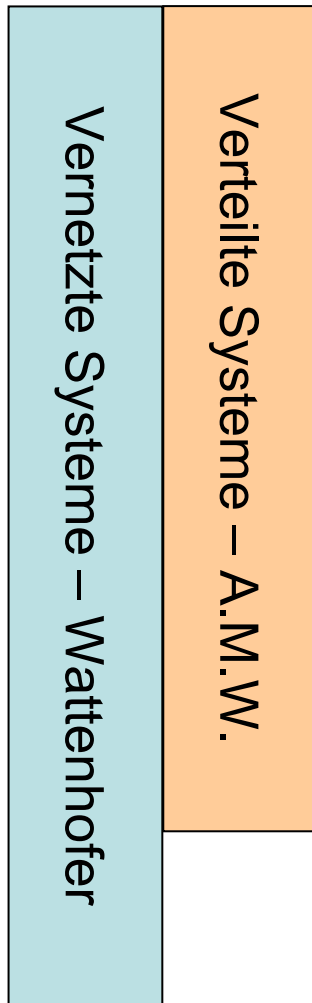

Enterprise Application Integration\* – Alonso

Parallel and Distr. Databases\* – Alonso

Ubiquitous Computing\* – Mattern

Distributed Algorithms\* – Mattern

Mobile Computing\* – Wattenhofer

Principles of Distributed Computing\* – Wattenhofer

Web Algorithms – Wattenhofer & Widmayer

More! See [www.tik.ee.ethz.ch](http://www.tik.ee.ethz.ch) or [www.pc.inf.ethz.ch](http://www.pc.inf.ethz.ch).

